



# WA 2293

Automatic Transformer  
Winding Analyser

Leaflet



## HAEFELY

Current and voltage – our passion

Designed by





## MULTI-PURPOSE AUTOMATIC POWER TRANSFORMER WINDING ANALYSER

The 2293 is an automatic winding analyser, optimized for three phase power and distribution transformer measurements.

It uniquely combines winding resistance measurement, turns ratio, dynamic resistance measurement, core demagnetization, transformer type detection, magnetic balance, short circuit impedance and heat run test (temperature rise and cooling curve) in the fastest, single instrument solution in the market.

A simple "one-time-connection" system drastically reduces measuring time: once connected all tests can be performed in a row without any reconnection.

The built-in, simultaneous winding magnetization method guarantees fast and reliable resistance measurements. Stable measurements are reached even on large power transformers with delta windings on the low voltage side. A progressive method for measuring transformer turns ratio, guarantees results closer to the nominal ratio even in large power transformers with tertiary windings.

Dynamic resistance measurement on tap changer, performs an efficient and reliable check of the transformer tap changer.

The demagnetization function eliminates the magnetic remanence, which can cause faulty measurements, high inrush currents and incorrect operation of protective relays.

Short circuit impedance test, at reduced current, helps to locate mechanical damages. In addition, the magnetic balance test can detect faults in the transformer magnetic core.

Personnel safety is guaranteed by an emergency button, as well as a state-of-the-art active discharge circuit, and a caution indicator that continues to operate even without line power. An optional interlock connector can be ordered.

## Powerful & Compact with "One-Time Connection"

32A and 18 kg multi-purpose winding analyser. Once connected, all tests are done without reconnection.

## FEATURES

Multi-purpose winding analyser - all in one solution.

Simple "one-time connection" system.

Unique simultaneous winding magnetization method for winding resistance measurements.

Touchscreen interface with full graphical test visualization.

Dynamic resistance for tap changer diagnosis, automatic tap changer control device.

Advanced procedure for turns ratio and phase displacement measurement.

Demagnetization function.

Automatic magnetic balance test.

Short circuit impedance at reduced current.

## APPLICATIONS

The 2293 is a valuable tool for factory test, acceptance test and regular maintenance on:

- Power and distribution transformers
- All types of HV windings

## ADVANTAGES

- One device for transformer winding resistance, turns ratio, arbitrary phase, vector group check, demagnetization, dynamic resistance, short circuit impedance, magnetic balance and heat run test (heat rise and cooling curve).
- Once connected, can perform all tests in all phases on both windings.
- More compact and lightweight solution in comparison to traditional equipment with up to 100A test current.
- Easy operation.
- Fully automated twinding resistance and tap changer test.
- Measurement also on non-regular phase displacements (arbitrary phase shifted transformers).
- Transformer is returned to a demagnetized status after winding resistance measurement or before putting the transformer into service.
- Magnetic core fault detection.
- Mechanical damage detection.





## WA 2293 - FLEXIBLE

The available software add-ons, allow adding features while the device is live without the need of hardware modifications or recalibrations. Just acquire the additional software add-on and the new feature will be automatically included.

The add-on architecture, allows device optimization for factory use, on-site use, or both.

**WINDING RESISTANCE**  
Transformer winding resistance is a routine test for all manufactured power transformers. In the field, changes in the winding resistance with time, can indicate looseness or overheating.

**TURNS RATIO**  
Transformer turns ratio validates the transformer design, or detects incorrect number of turns. In the field, changes in the turns ratio could indicate shorted turns, core related faults or mechanical damages.

**ARBITRARY PHASE SHIFT**  
Special transformers, like phase shifting or arc furnace, which don't follow the standard 30° phase steps can be easily measured.

**DYNAMIC RESISTANCE ON TAP CHANGER**  
Dynamic resistance measurement is a reliable check of the transformer tap changer. Discontinuities or deviations between different taps are signs of tap changer fault.

**SHORT CIRCUIT IMPEDANCE**  
Changes in the short circuit impedance along transformer life, is normally an indication of mechanical damage.

**HEAT RUN TEST - HEAT RISE**  
The 2293 monitors the transformer temperature during the heat rise and includes pre-configured tests according to IEC and ANSI standards, informing when stabilization has been reached.

**TRANSFORMER CONNECTION**  
Transformer connection finder is used in repairing shops, or during routine maintenance, to measure transformers with non available or deleted nameplates.

**HEAT RUN TEST - COOLING CURVE**  
During the cooling curve, the 2293 measures HV and LV side resistances simultaneously and accurately. Efficient and accurate acquisition of the data points allows easy drawing of the cooling curve.

**DEMAGNETIZATION**  
A magnetized core can generate large over currents when connected to the grid (inrush current), or generates wrong results during other measurements (e.g., frequency response analysis).

**MAGNETIC BALANCE**  
Magnetic balance test is performed to detect faults in the magnetic core. The test looks for changes in the reluctance of the magnetic circuit caused by defects in the magnetic core structure, shifting or shape changes in the windings or inter-turn insulation fault.

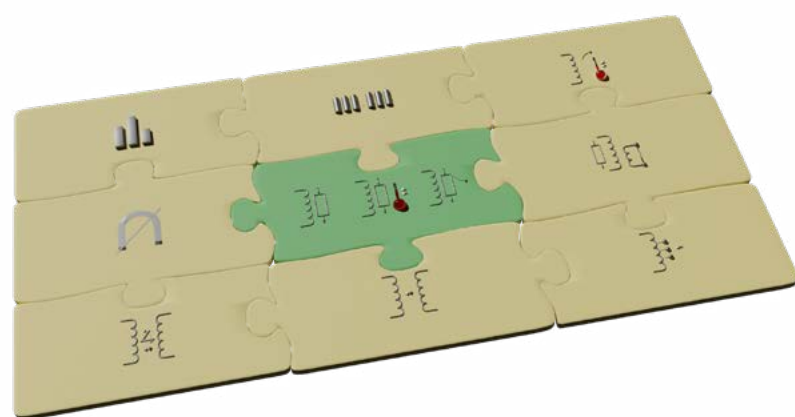

## WA 2293 - FACTORY OPTIMIZED

The WA 2293 is the perfect device for factory test according to IEC 60076. Its accuracy and reliability make it a must have for transformer tests.

The 2293 add-ons concept allows to configure the device with the most important measurements to perform routine test on both distribution and power transformers.

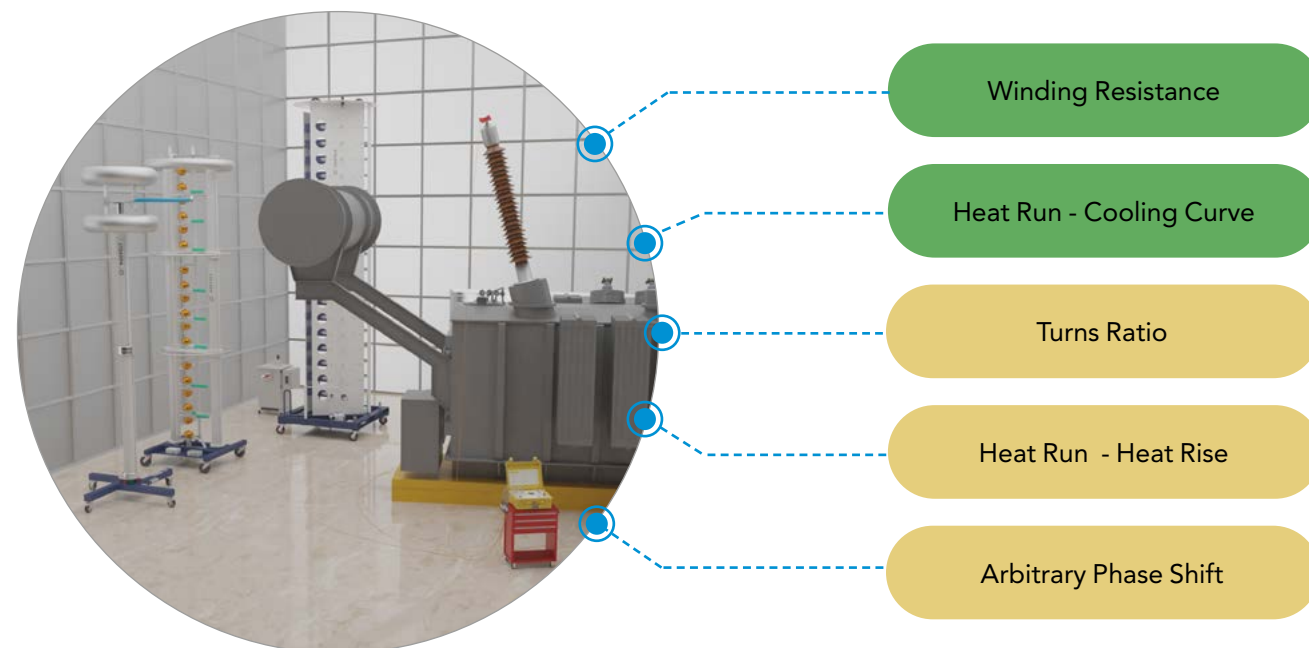

## WA 2293 - ON-SITE OPTIMIZED

Time-based or status-based maintenance requires reliable devices with trustable measurement results to decide the transformer status. Using the 2293 add-ons feature, the device

can be tuned to be used on this particular field. Being lightweight and easy to connect, makes it the perfect partner to perform on-site measurements.

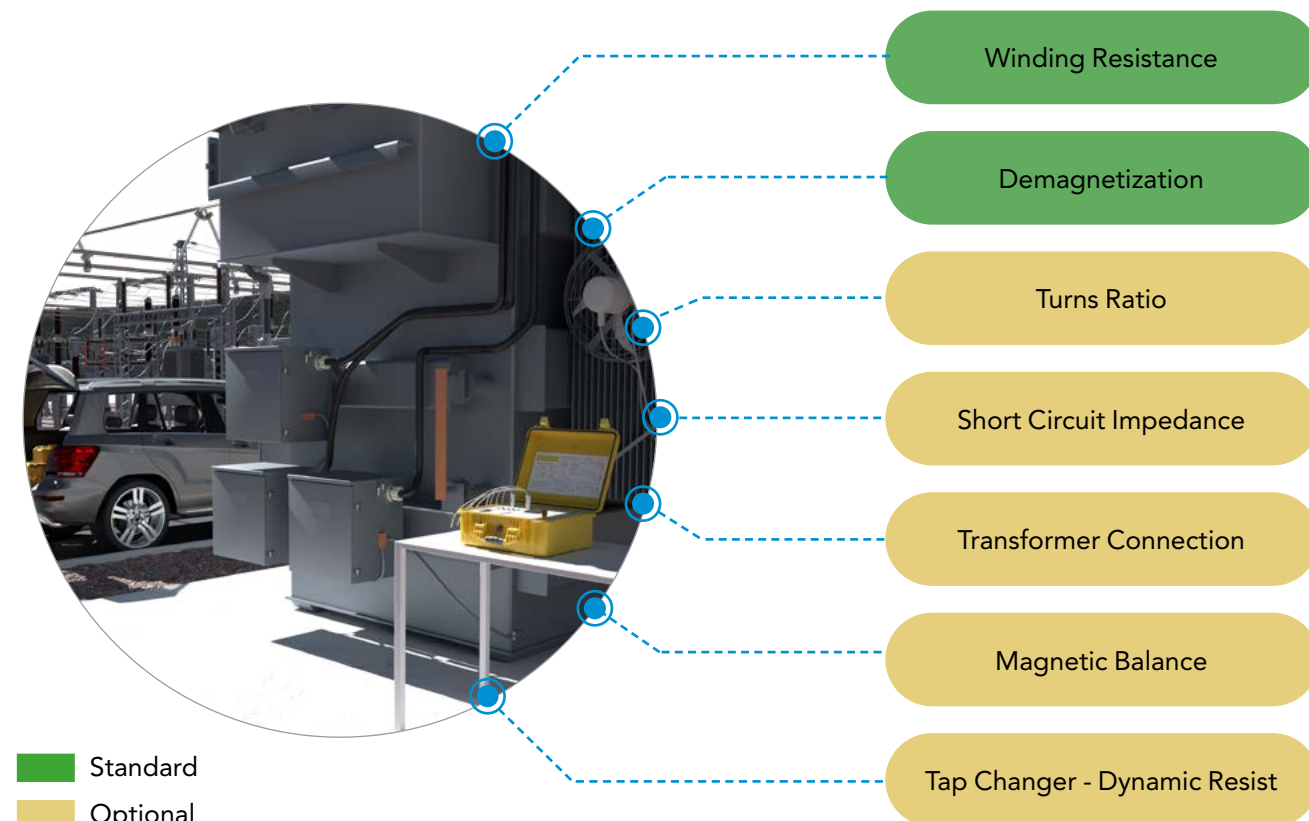

Standard  
Optional

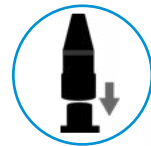

### Quick Connection System

The twin-lock connectors and the one-time connection system help to reduce connecting time drastically.



### Temperature Measurement

Temperature probes inputs (6 included, up to 30 with the 2293/TEMPEXT) to monitor the test object temperature during resistance measurement or heat run test.

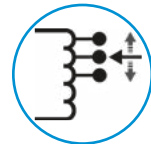

### Tap Changer Control

Motorized tap changers can be remotely operated by the device to automate measurements.



### Touch Screen

Self-guided graphical interface and touch-panel makes device user-friendly.

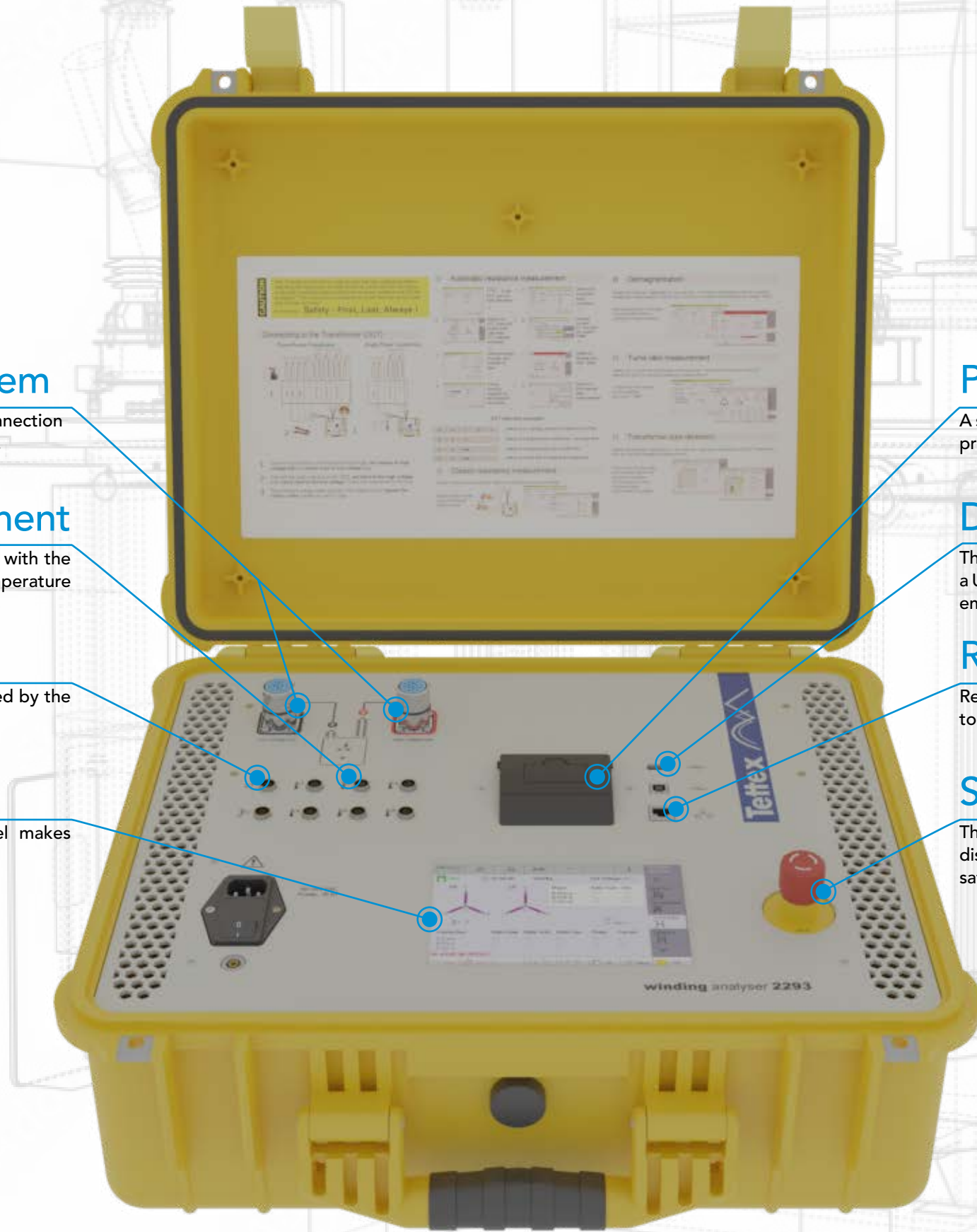
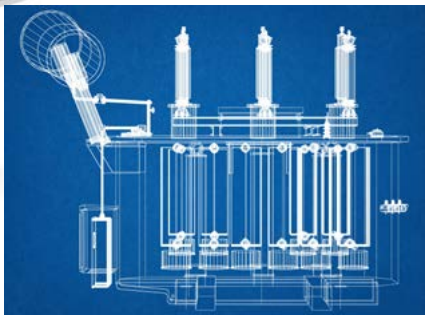

### Printer

A simple test report can be printed with the built-in thermal printer.



### Data Handling

The 2293 allows easy data handling. Results can be saved on a USB memory stick or downloaded to a computer using the embedded FTP server.



### Remote Control

Remote control is performed through the Ethernet interface to integrate the device in an automated production platform.



### Safety Switch

The safety switch can be turned off at any point of time to disconnect the device, thereby guaranteeing complete safety.







## WINDING RESISTANCE

The simultaneous winding magnetisation method (patented) together with the integrated DC power-supply guarantees fast and reliable winding resistance measurements. The 7" touch screen full graphical interface guides the operator through the single test procedures.

Independent currents can be selected for each winding, which guarantees reliable results even in transformers with large differences between windings.

With one optional temperature probe (available for liquids and magnetic), results can be automatically referenced to any target temperature (for example 75°).

With Simultaneous Winding Magnetization Test a complete transformer in a fraction of time!

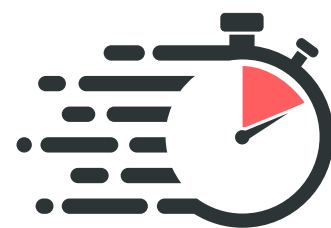
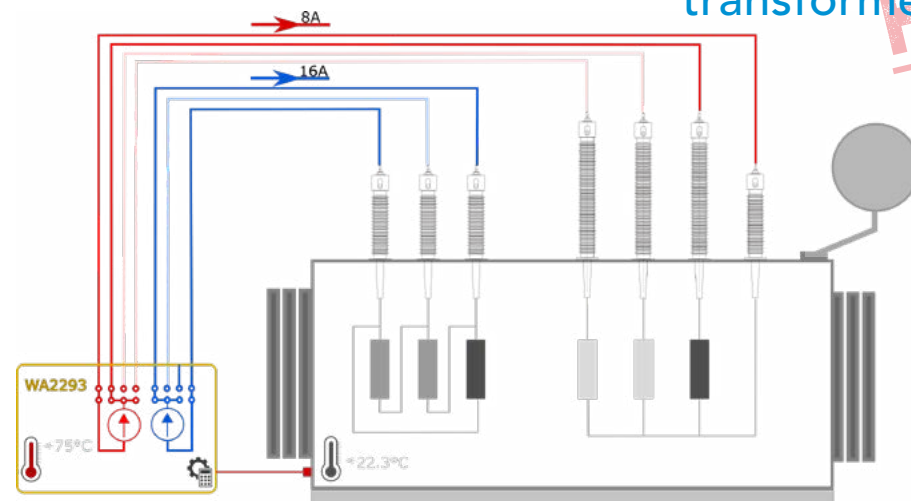
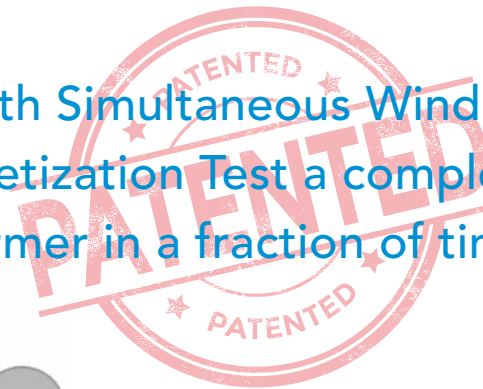

## URNS RATIO

The AC power supply integrated in the 2293 allows full automatic measurement of turns and voltage ratio, ratio deviation, phase displacement and excitation current of transformers.

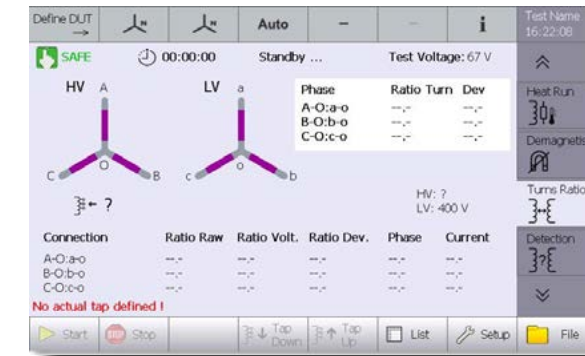

The specially developed algorithmic included in compensated mode reduces the influence of leakage flux while using low voltage, giving results much closer to the nominal ratio.

## ARBITRARY PHASE SHIFT

Arbitrary phase shifts or those that do not follow the 30° phase steps between the primary and secondary winding are common in special transformers like phase shifting, rectifier / furnace and traction transformers.

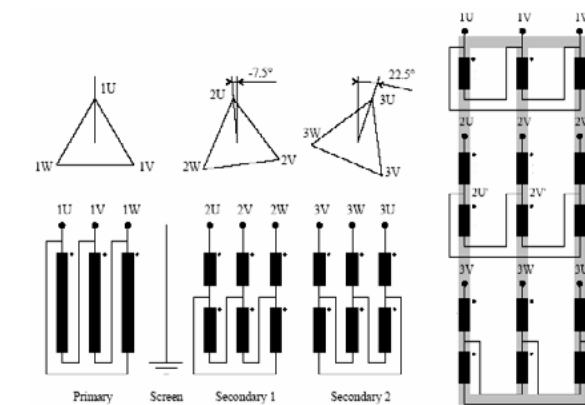

With the optional arbitrary phase shift software key (2293/SKAP), the 2293 can measure turns and voltage ratio, phase displacement and excitation current of these special type transformers.

## VECTOR GROUP DETECTION

The included type detection feature works as a nameplate guesser. It helps the user to determine the correct transformer configuration by showing the possible types and eliminating the wrong vector groups during the automatic detection process.

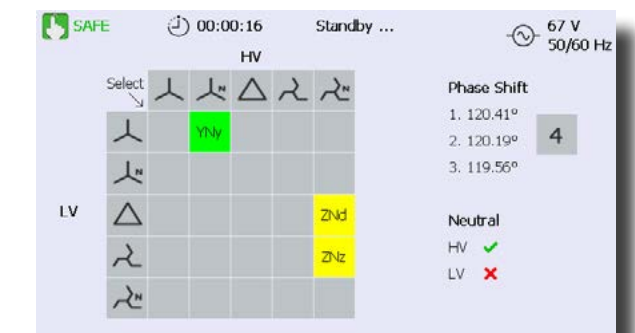
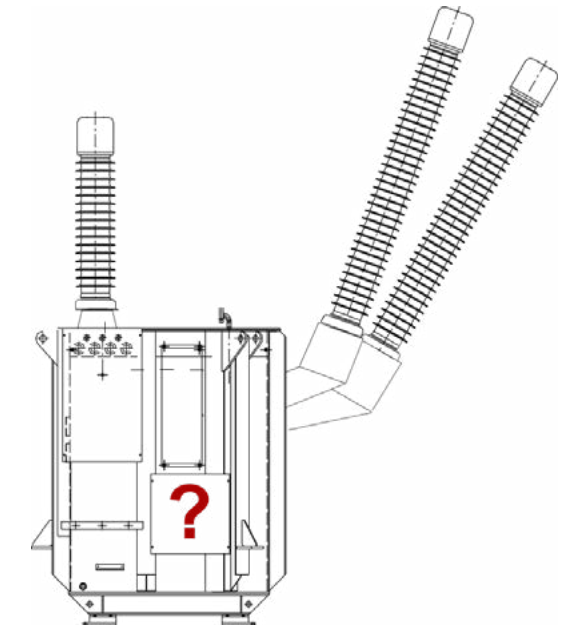



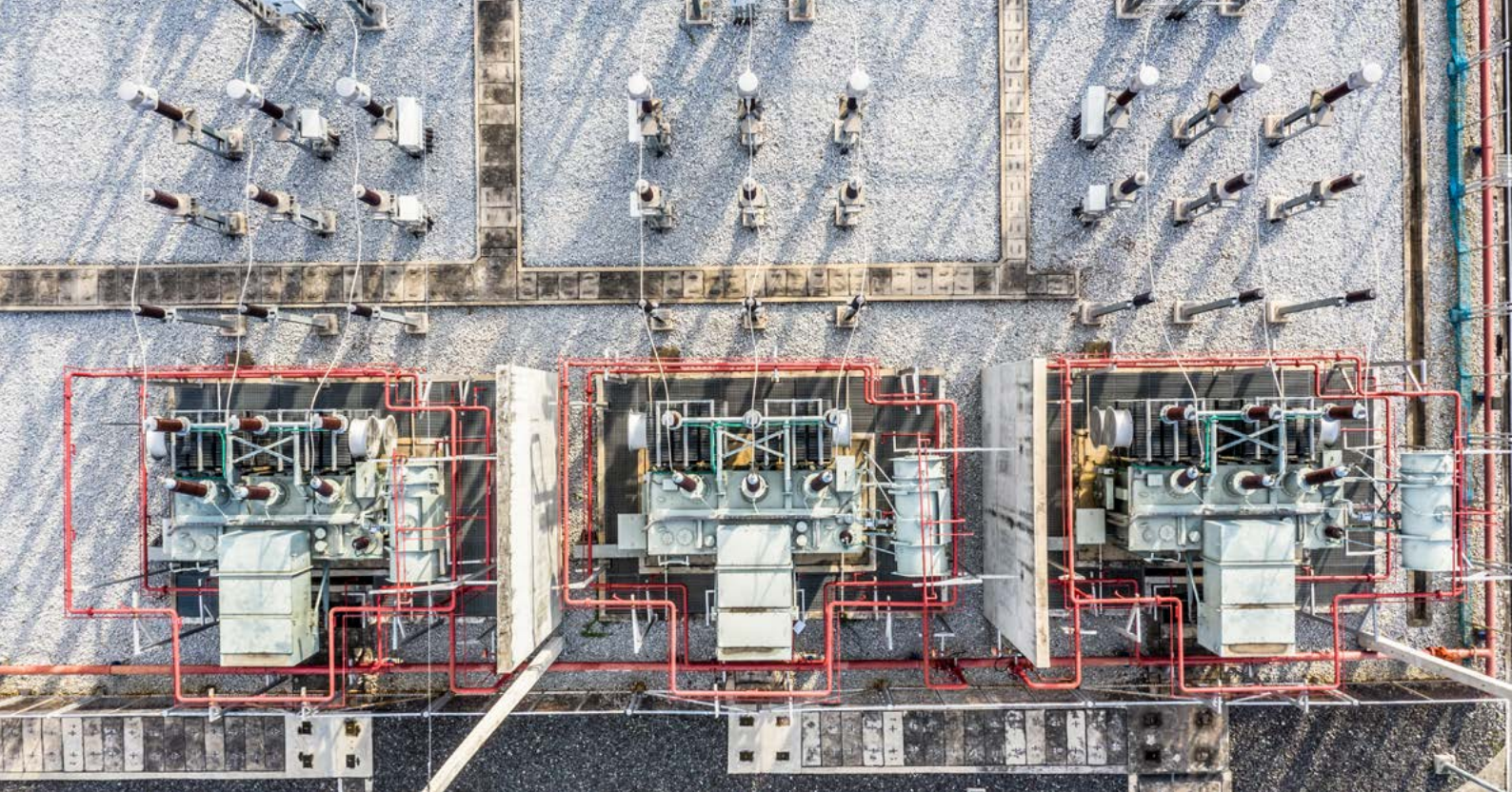

### TAP CHANGER - DYNAMIC RESISTANCE

The main function of the on load tap changer is to switch between transformer taps without interrupting the current. The 2293 registers the current while tap changer is operated and records the values at a defined sample rate.

Discontinuities or deviations between different taps are a sign of tap changer fault.

The tap changer test with the 2293 is done automatically and without reconnection. In addition, the tap changer control accessory allows a complete automatic sequence without human intervention.

Calculation of the main curve parameters like time to rise, time to fall or delta, for failure detection, is automatically done.

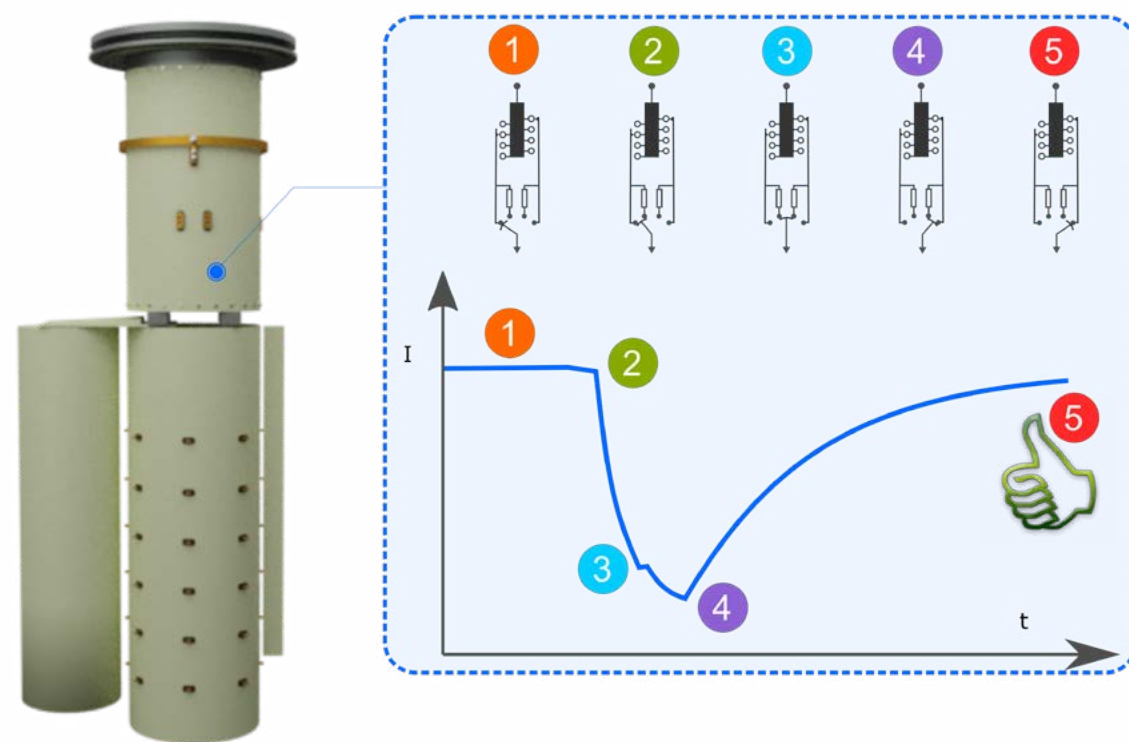

### MAGNETIC BALANCE TEST

Magnetic balance test is performed to detect faults in the magnetic core. The test looks for changes in the reluctance of the magnetic circuit caused by defects in the magnetic core structure, shifting or shape changes in the windings or inter turn insulation fault.

The test is performed on three phase transformers by applying a voltage on one of the phases and measures the voltage on the other two. The induced voltage will depend on the limb position into the core as the following table.

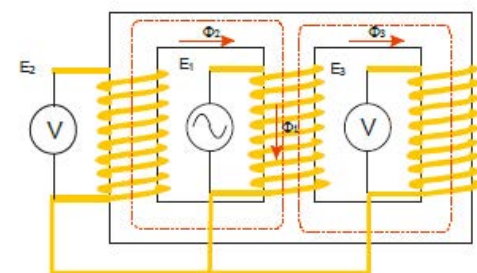

|                  | U (A) | V (B) | W (C) |
|------------------|-------|-------|-------|
| Voltage to U (A) | 100%  | 66%   | 33%   |
| Voltage to V (B) | 50%   | 100%  | 50%   |
| Voltage to W (C) | 33%   | 66%   | 100%  |

The 2293 performs the magnetic balance test automatically and without any reconnection. Test results are shown graphically for a better understanding.

Imbalances will be graphically noted including the involved phases.

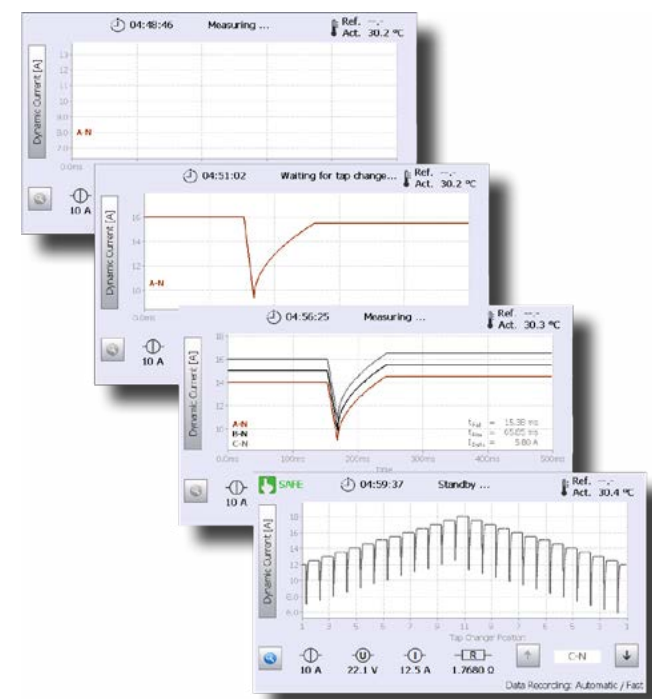

### SHORT CIRCUIT IMPEDANCE

Short circuit impedance is a routine test done to all transformers after manufacture and specified in the transformer nameplate.

Changes in the short circuit impedance along transformer life is normally an indication of mechanical damages.

The 2293 automatically performs a short circuit impedance test at reduced voltage on power and distribution transformers and calculates the three phase equivalent short circuit impedance for comparison with previous test or with nameplate values.

### DEMAGNETISATION FUNCTION

After a power or distribution transformer is disconnected from the power grid or when a DC current is applied to it, for example during a routine winding resistance measurement, the transformer core is likely to have some remnant magnetism. This remnant magnetism will generate high over currents when the transformer is reconnected to the grid, and this is commonly known as transformer inrush current.

In addition, magnetic remnant has an adverse effect on other measurements like FRA or TTR.

The 2293 includes a fully automatic demagnetisation feature which eliminates the magnetic remnant. Select the winding where demagnetisation needs to be performed and press start. The unit visualizes the whole demagnetisation cycle and performs the correct core demagnetisation in seconds.

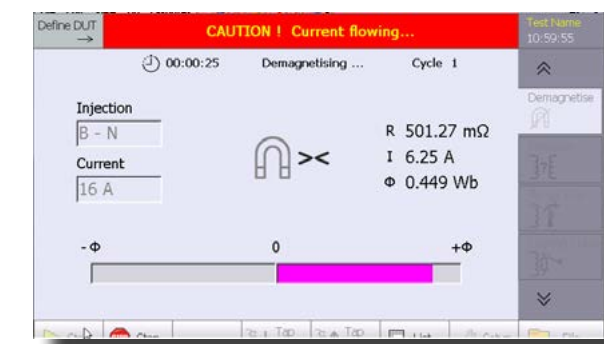
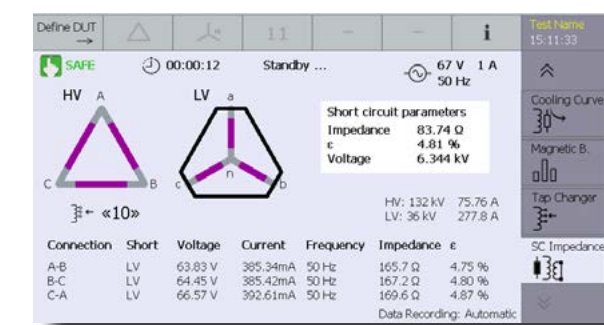





## HEAT RUN TEST

Heat run test on transformers consist of two steps:

- Heat Rise: The transformer runs at nominal losses and transformer temperature rises.
- Cooling Curve: The transformer is disconnected and winding resistance is measured.

The 2293 performs the measurements on both steps. It monitors the transformer temperature during the heat rise and measures HV and LV side resistances simultaneously during the cooling curve.

## HEAT RISE

For the heat rise, connection of the temperature sensors could not be easier. The included 6 temperature inputs can be easily extended up to 30 by using the optional temperature extension box (2293/TEMP). The available magnetic and liquids temperature probes (2293/TEMP2, 2293/TEMP1) are easily connected to the transformer. Probe configuration is done graphically (oil, radiator top, radiator bottom, ambient...).

In addition, pre-configured tests according to ANSI and IEC standards are included, calculating the transformer temperature in real time and informing when stabilization is reached.

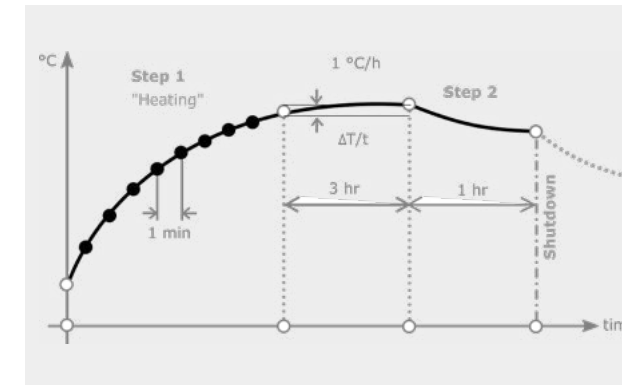

## COOLING CURVE

For the cooling curve, the 2293 can measure HV and LV side resistances simultaneously and accurately. It provides efficient and accurate acquisition of the required data points to allow the user to draw the necessary cooling curve. Results can be easily exported to CSV files to calculate the winding temperature at switching off time.

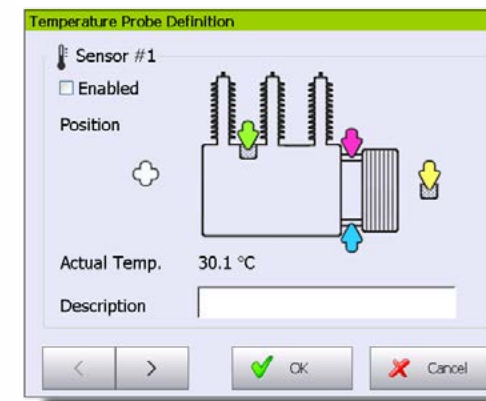
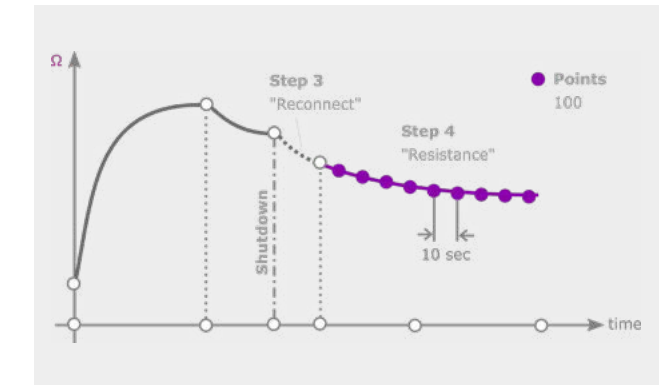

Connect up to 30 temperature sensors to the WA 2293

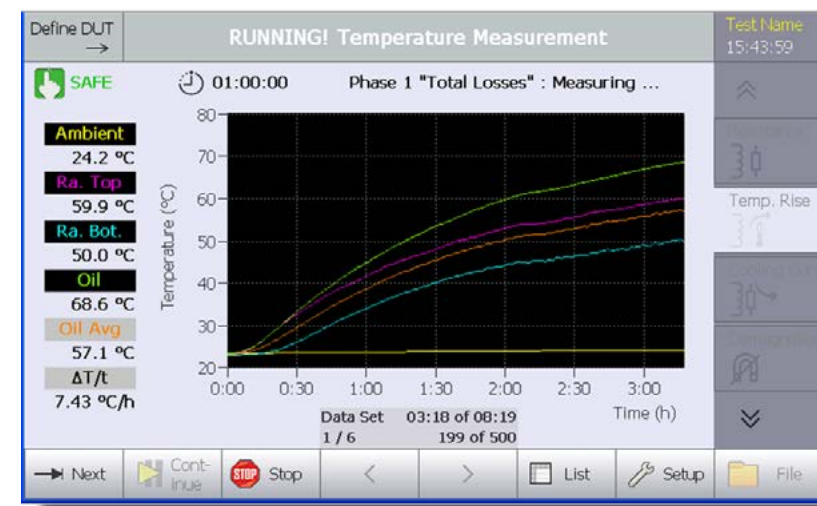

Pre-configures test according to ANSI & IEC



## 2293 BASIC SPECIFICATIONS

### Resistance Measurement

|                           |                                    |
|---------------------------|------------------------------------|
| Max. Measuring Current DC | 32A (user selectable)              |
| Max. Charging Voltage DC  | 100V                               |
| Range                     | 0.1 $\mu\Omega$ ... 300 k $\Omega$ |
| Accuracy                  | 0.1% $\pm$ 0.5 $\mu\Omega$         |

### Turns Ratio Measurement

|          |                 |
|----------|-----------------|
| Range    | 1.0 ... 100'000 |
| Accuracy | 0.05%           |

Complete technical specifications in the WA 2293 datasheet available at [www.haefely.com](http://www.haefely.com)

## STANDARD PACKAGE

|   |         |         |  |         |
|---|---------|---------|--|---------|
| 1 | WA 2293 | 3490068 | Measuring Bridge (Portable and rack mounted version) | WA 2293 |
|---|---------|---------|--|---------|

### Including

- Winding resistance measurement
- Demagnetization measurement
- Heat run - Cooling curve measurement
- 8 measuring cables of 10 m length equipped with Kelvin probes
- Cable bag
- Test certificate
- Instruction manual

## EXTENSIONS

|   |   |            |  |
|---|---|------------|--|
| 2 | Software Add-ons                            |            |  |
|   | 3-phase transformer turns ratio measurement | 2293/SKTTR |  |
|   | Arbitrary phase shift (2293/SKTTR needed)   | 2293/SKAP  |  |
|   | Heat rise temperature measurement           | 2293/SKTR  |  |
|   | Magnetic balance measurement                | 2293/SKMB  |  |
|   | Tap changer dynamic resistance measurement  | 22937/SKTC |  |
|   | Short circuit impedance measurement         | 2293/SKSC  |  |
| 3 | Extended Warranty                           |            |  |
|   | 2 years                                     | WA 2293    |  |
|   | 3 years                                     | WA 2823    |  |

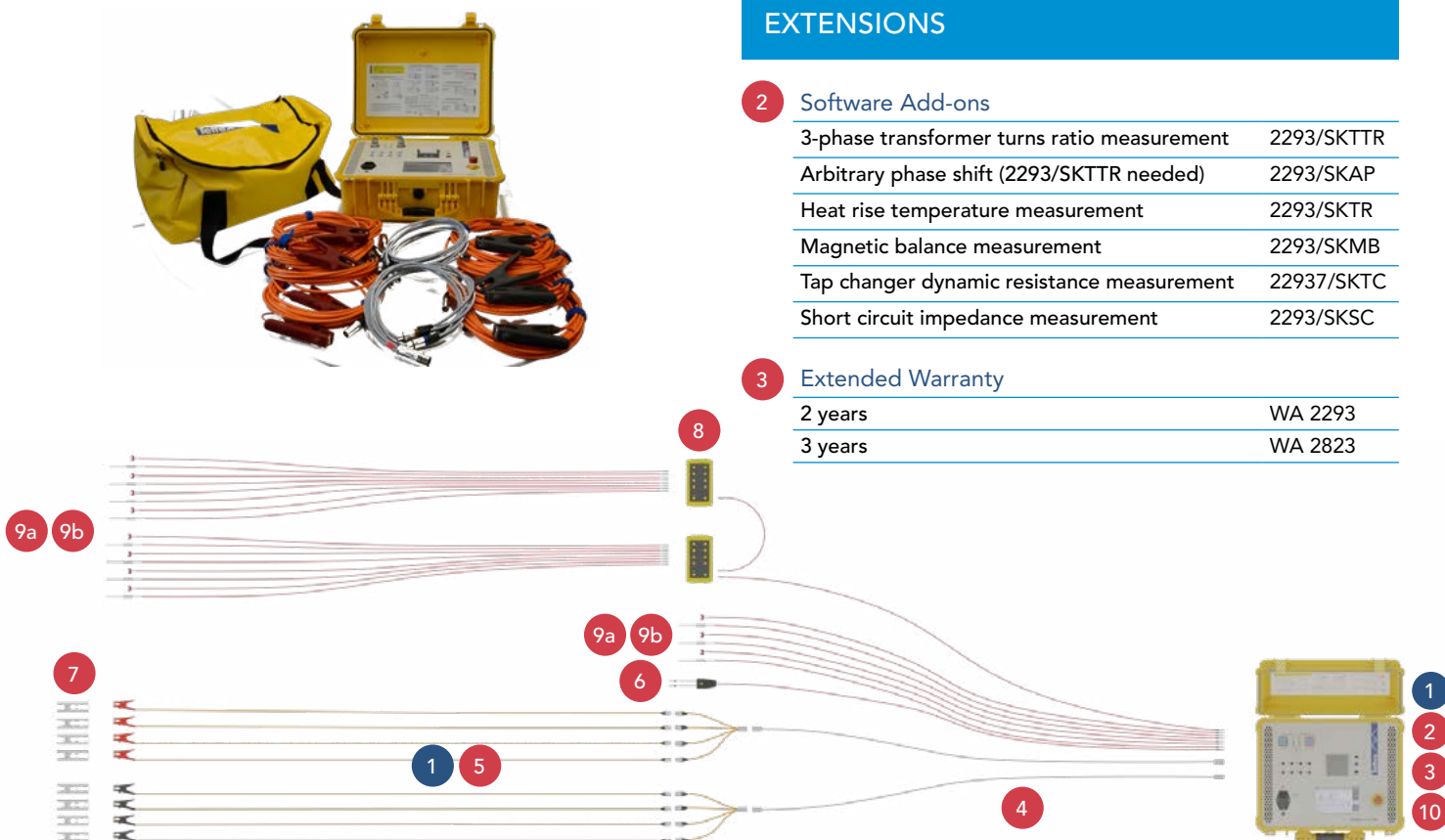

## ACCESSORIES

### Measurement Cables & Clamps

|   |  |  |                        |
|---|--|--|------------------------|
| 4 | Extension cable 10 m high voltage side<br>Extension cable 10 m low voltage side                                |  | 2293/10HV<br>2293/10LV |
| 5 | Additional measuring cables (HV & LV, 8 cables), 3 m length  |  | 2293/MK3               |
| 6 | Tap changer control cable, allows remote tap changer control from measuring device and automate test sequences |  | 2293/TAP               |
| 7 | Extension clamps to increase the maximum opening distance of the standard clamps                               |  | ExtClamp               |

### Temperature Sensors

|    |   |  |              |
|----|---|--|--------------|
| 8  | Temperature extension box to connect up to 8 additional temperature sensors (max. 3 extension boxes per device) |  | 2293/TEMPEXT |
| 9a | Temperature probe for liquids   |  | 2293/TEMP1   |
| 9b | Temperature probe magnetic  |  | 2293/TEMP2   |
|    | Laser infrared contactless thermo/hygrometer  |  | TEMP         |
| 10 | Interlock provision   |  | 2293/IT      |

## ENTIRE SOLUTIONS FOR TRANSFORMERS

Haefely offers a complete product line for transformer tests, both in the factory and on-site.

|                          | WA 2293 | MIDAS micro 2283 | FRA 5311 | RVM 5462a |
|--------------------------|---------|------------------|----------|-----------|
| Winding Resistance       | ○       |                  |          |           |
| TTR Turns Ratio          | ○       |                  |          |           |
| Heat Run Test            | ○       |                  |          |           |
| Demagnetize              | ○       |                  |          |           |
| Cap & Tan (Diss. Factor) |         | ○                |          |           |
| Short Circuit Impedance  | ○       |                  |          |           |
| FRA Frequency Response   |         |                  | ○        |           |
| RVM Water Content        |         |                  |          | ○         |
| Excitation Current       | ○       | ○                |          |           |





## Global Presence

### EUROPE

HAEFELY AG  
Birsstrasse 300  
4052 Basel  
Switzerland

☎ +41 61 373 4111  
✉ sales@haefely.com  
💻 www.haefely.com

### CHINA

HAEFELY AG Representative Office  
8-1-602, Fortune Street, No. 67,  
Chaoyang Road, Beijing 100025  
China

☎ +86 10 8578 8099  
✉ sales@haefely.com.cn  
💻 www.haefely.com

### INDIA

HAEFELY India Service Office  
C/o Pfiffner Instrument Transformers Pvt. Ltd.  
176, 178/2 Sarul, Viholi  
Nashik 422 010, India.

☎ +1 800 266 4052 (toll free)  
✉ sales@haefely.com  
💻 www.haefely.com

This document has been drawn up with the utmost care. We cannot, however, guarantee that it is entirely complete, correct or up-to-date. Subject to change without notice.

V2109



**HAEFELY**

Current and voltage – our passion



HIGH VOLTAGE

INSTRUMENT

EMC

