

Measuring Battery Quality

Cells - Modules - Packs

Quality Testing
Maintenance
Inspections
R & D

3561,3561-01



BT3561A



BT3562A



BT3563A



BT3562-01, BT3563-01



BT3564



BT4560



BT3554-50, BT3554-51, BT3554-52



*1: BT3561A, BT3562A, BT3563A, BT3562-01, BT3563-01 only *2: BT3554-50, BT3554-51, BT3554-52 only

Measuring Battery Quality

A variety of processes must be completed before a battery becomes a finished product and each process level requires an appropriate testing measurement method.

HIOKI battery testers are ideal for use in testing, development and inspections after cell completion.



Processes after cell completion

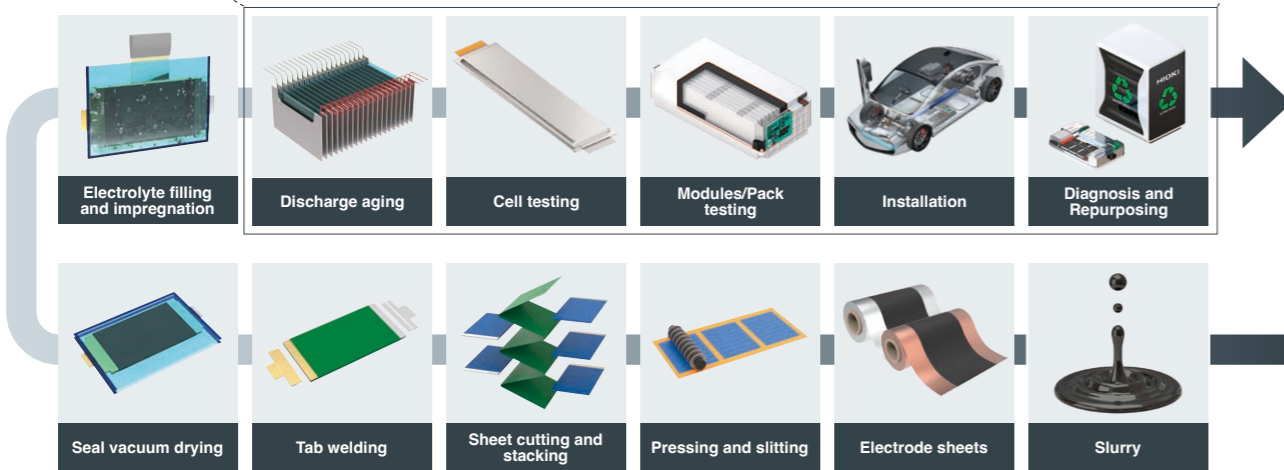
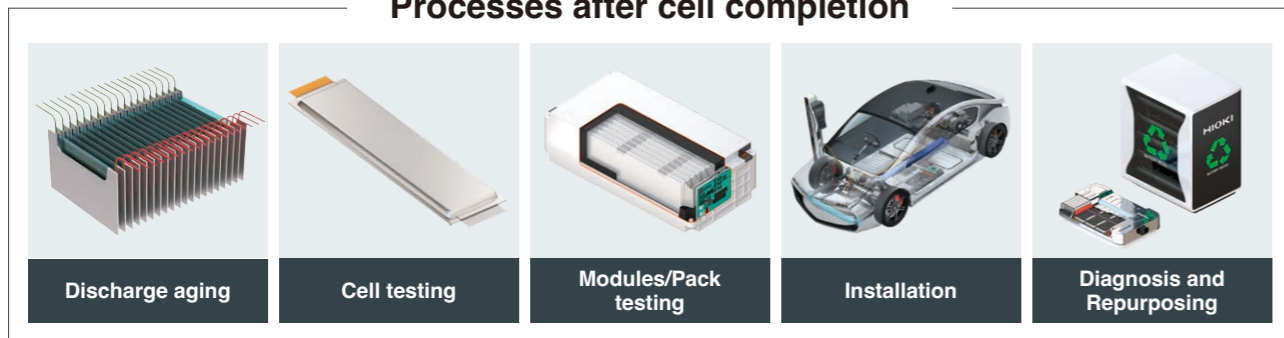

Lithium-ion Battery Production Processes

Acceptance/shipping inspections

Inspect the quality of completed cells, modules, and packs on production lines. Measure internal resistance (AC-IR) and open-circuit voltage (OCV) to check battery quality.

Quality Testing
P.6 to P.16

Measuring open-circuit voltage with a high degree of precision

High-precision OCV measurement makes it possible to detect defects earlier in the production process.

DC VOLT METER DM7276

[Learn more P.9](#)

Increasing the number of test channels

Increase the number of test channels and automatically switch between them while measuring.

SWITCH MAINFRAME SW1002

[Learn more P.14, P.15](#)

Diagnosing degradation in batteries

Diagnose whether batteries embedded in a UPS or other system have degraded.

Maintenance Inspections
P.17

Analyzing batteries

Analyze the battery characteristics by frequency sweep impedance measurement and equivalent circuit analysis.

BT4560

Measuring impedance over a broader frequency band

Broaden the measurement frequency range.

CHEMICAL IMPEDANCE ANALYZER IM3590

[Learn more P.19](#)

Analyzing fuel cells (FCs)

Measure the internal resistance (1 kHz) of fuel cells during cycle testing.

BT3564-FC (Special specifications)

Performing dynamic impedance measurement

Measure the impedance of fuel cells or LIBs during cycle testing.

POWER ANALYZER PW6001

[Learn more P.20, P.21](#)

R & D
P.18 - P.21

Battery tester lineup

Application	Acceptance/shipping inspections					
	Small cells for general purpose High speed sorting	Small cells for power motors Small packs of up to 60 V	Large cells for xEVs Mid-sized packs of up to 100 V	Large packs for xEVs Large packs of up to 300 V		
Model	3561, 3561-01	BT3561A	BT3562A	BT3563A		
Appearance						
Measurement method	AC four-terminal method	AC four-terminal method	AC four-terminal method	AC four-terminal method		
Measurement frequency	1 kHz ±0.2 Hz	1 kHz ±0.2 Hz	1 kHz ±0.2 Hz	1 kHz ±0.2 Hz		
Rated input voltage	±22 V DC	±60 V DC	±100 V DC	±300 V DC		
Maximum rated voltage to earth	±60 V DC	±60 V DC	±100 V DC	±300 V DC		
Measurement parameters	Resistance measurement ranges	3 mΩ	N/A	N/A	3.1000 mΩ, 0.1 μΩ, 100 mA	3.1000 mΩ, 0.1 μΩ, 100 mA
		30 mΩ	N/A	31.000 mΩ, 1 μΩ, 100 mA	31.000 mΩ, 1 μΩ, 100 mA	31.000 mΩ, 1 μΩ, 100 mA
		300 mΩ	310.00 mΩ, 10 μΩ, 10 mA	310.00 mΩ, 10 μΩ, 10 mA	310.00 mΩ, 10 μΩ, 10 mA	310.00 mΩ, 10 μΩ, 10 mA
		3 Ω	3.1000 Ω, 100 μΩ, 1 mA	3.1000 Ω, 100 μΩ, 1 mA	3.1000 Ω, 100 μΩ, 1 mA	3.1000 Ω, 100 μΩ, 1 mA
		30 Ω	N/A	31.000 Ω, 1 mΩ, 100 μA	31.000 Ω, 1 mΩ, 100 μA	31.000 Ω, 1 mΩ, 100 μA
	Max. display, resolution, measurement current	300 Ω	N/A	310.00 Ω, 10 mΩ, 10 μA	310.00 Ω, 10 mΩ, 10 μA	310.00 Ω, 10 mΩ, 10 μA
		3 kΩ	N/A	3.1000 kΩ, 100 mΩ, 10 μA	3.1000 kΩ, 100 mΩ, 10 μA	3.1000 kΩ, 100 mΩ, 10 μA
	Basic accuracy	3 mΩ range	N/A	N/A	±0.5% rdg ±10 dgt	±0.5% rdg ±10 dgt
		30 mΩ range or more	±0.5% rdg ±5 dgt	±0.5% rdg ±5 dgt	±0.5% rdg ±5 dgt	±0.5% rdg ±5 dgt
	Voltage measurement ranges	6 V	N/A	6.000 00 V, 10 μV	6.000 00 V, 10 μV	6.000 00 V, 10 μV
20 V		19.999 9 V, 100 μV	N/A	N/A	N/A	
60 V		N/A	60.000 0 V, 100 μV	60.000 0 V, 100 μV	60.000 0 V, 100 μV	
100 V		N/A	N/A	100.000 V, 1 mV	N/A	
300 V		N/A	N/A	N/A	300.000 V, 1 mV	
Max. display, resolution	1000 V	N/A	N/A	N/A	N/A	
Basic accuracy		±0.01% rdg ±3 dgt	±0.01% rdg ±3 dgt	±0.01% rdg ±3 dgt	±0.01% rdg ±3 dgt	
Response time ¹⁾		3 ms	10 ms	10 ms	10 ms	
Sampling period ²⁾	Ω or V	4 ms, 12 ms, 35 ms, 150 ms	4 ms, 12 ms, 35 ms, 150 ms	4 ms, 12 ms, 35 ms, 150 ms	4 ms, 12 ms, 35 ms, 150 ms	
	EX.FAST, FAST, MEDIUM, SLOW	QV	7 ms, 23 ms, 69 ms, 252 ms	8 ms, 24 ms, 70 ms, 253 ms	8 ms, 24 ms, 70 ms, 253 ms	8 ms, 24 ms, 70 ms, 253 ms
Allowable total line resistance ^{1) 3)} (error detection)	SENSE line	N/A, N/A, 20 Ω, 20 Ω	N/A, 6.5 Ω, 30 Ω, 30 Ω	6.5 Ω, 6.5 Ω, 30 Ω, 30 Ω	6.5 Ω, 6.5 Ω, 30 Ω, 30 Ω	
	Ranges: 3 mΩ, 30 mΩ, 300 mΩ, 3 Ω	SOURCE line	N/A, N/A, 50 Ω, 500 Ω	N/A, 5.5 Ω, 15 Ω, 150 Ω	5.5 Ω, 5.5 Ω, 15 Ω, 150 Ω	5.5 Ω, 5.5 Ω, 15 Ω, 150 Ω
Open terminal voltage	Ranges: 30 mΩ or less, 300 mΩ, 3 Ω or more	N/A, 7 V, 7 V peak	25 V, 7 V, 4 V peak	25 V, 7 V, 4 V peak	25 V, 7 V, 4 V peak	
Interface	LAN (TCP/IP, 10BASE-T/100BASE-TX)	N/A	YES	YES	YES	
	RS-232C ⁴⁾ (Max. 38400 bps)	YES	YES	YES	YES	
	USB	N/A	N/A	N/A	N/A	
	GP-IB	YES (3561-01 Only)	N/A	N/A	N/A	
	EXT I/O (37-pin Handler interface)	YES (36-pin)	YES	YES	YES	
	Analog output (DC 0 V to 3.1 V)	N/A	YES	YES	YES	
Function	Contact check	YES	YES	YES	YES	
	Zero adjustment (±1000 counts)	YES	YES	YES	YES	
	Measurement current pulse output	N/A	YES	YES	YES	
	Comparator	Hi/ IN/ Lo	Hi/ IN/ Lo	Hi/ IN/ Lo	Hi/ IN/ Lo	
	Statistical calculations	Max. 30,000	Max. 30,000	Max. 30,000	Max. 30,000	
	Delay	YES	YES	YES	YES	
	Average	2 to 16 times	2 to 16 times	2 to 16 times	2 to 16 times	
	Panel saving/loading	126	126	126	126	
	Memory storage	400	400	400	400	
	LabVIEW [®] driver ⁵⁾	YES	YES	YES	YES	
Applicable standards	Safety: EN61010 EMC: EN61326 Class A	Safety: EN61010 EMC: EN61326 Class A	Safety: EN61010 EMC: EN61326 Class A	Safety: EN61010 EMC: EN61326 Class A		
Effect of radiated radio-frequency electromagnetic field	Resistant ⁶⁾	Resistant ⁶⁾	Resistant ⁶⁾	Resistant ⁶⁾		
Effect of conducted radiofrequency electromagnetic field	10 V	N/A	Resistant	Resistant		
	3 V	Resistant	Resistant	Resistant		
CE	YES	YES	YES	YES		
CSA ⁷⁾	N/A	YES	YES	YES		
Dimensions • Weight	215W × 80H × 295D mm (8.46W × 3.15H × 11.61D in) 2.4 kg (84.66 oz)	215W × 80H × 295D mm (8.46W × 3.15H × 11.61D in) 2.4 kg (84.66 oz)	215W × 80H × 295D mm (8.46W × 3.15H × 11.61D in) 2.4 kg (84.66 oz)	215W × 80H × 295D mm (8.46W × 3.15H × 11.61D in) 2.4 kg (84.66 oz)		





¹⁾: Typical value ²⁾: When the power supply frequency is 60 Hz ³⁾: Total line resistance = wiring resistance + contact resistance + DUT resistance ⁴⁾: Available as printer I/F
⁵⁾: LabVIEW[®] Driver is a registered trademark of National Instruments Corporation ⁶⁾: Test conditions were 80 MHz to 1 GHz at 10 V/m and 1 GHz to 6 GHz at 3 V/m, all at 80% AM
⁷⁾: Canadian Standards Association

Application	Acceptance/shipping inspections		R & D	Maintenance	
	Extra large packs for xEV, ESS 1000 V high voltage model	GP-IB model	Cells or packs up to 20 V Degree of deterioration for reuse	Large-scale UPS	
Model	BT3564	BT3562-01 BT3563-01	BT4560	BT3554-50 ^{*10} BT3554-51 ^{*10} BT3554-52 ^{*10}	
Appearance					
Measurement method	AC four-terminal method	AC four-terminal method	AC four-terminal pair method	AC four-terminal method	
Measurement frequency	1 kHz ±0.2 Hz	1 kHz ±0.2 Hz	0.10 Hz to 1050 Hz	1 kHz ±80 Hz	
Rated input voltage	±1000 V DC	BT3562-01: ±70 V DC BT3563-01: ±300 V DC	±5 V DC Special specification supports up to ±20 V DC	±60 V DC	
Maximum rated voltage to earth	±1000 V DC	BT3562-01: ±60 V DC BT3563-01: ±300 V DC	SOURCE-H, SENSE-H: ±5 V DC SOURCE-L, SENSE-L: 0 V DC	±60 V DC	
Measurement parameters	Resistance measurement ranges	3 mΩ	3.1000 mΩ, 0.1 μΩ, 100 mA	3.1000 mΩ, 0.1 μΩ, 100 mA	Resistance (R) 3.6000 mΩ, 0.1 μΩ, 1.5 A 12.0000 mΩ, 0.1 μΩ, 500 mA 120.000 mΩ, 1 μΩ, 50 mA [The number of waveforms] Frequency: FAST, MEDIUM, SLOW 0.10 Hz to 66 Hz: 1 wave, 2 waves, 8 waves 67 Hz to 250 Hz: 2 waves, 8 waves, 32 waves 260 Hz to 1050 Hz: 8 waves, 32 waves, 128 waves Reactance (X) ±3.6000 mΩ, 0.1 μΩ, 1.5 A ±12.0000 mΩ, 0.1 μΩ, 500 mA ±120.000 mΩ, 1 μΩ, 50 mA Impedance (Z) 3.6000 mΩ, 0.1 μΩ, 1.5 A 12.0000 mΩ, 0.1 μΩ, 500 mA 120.000 mΩ, 1 μΩ, 50 mA Phase angle (θ) ±180.000°, 0.001° [Basic accuracy] Refer to P.19 Voltage (V) ±5.10000 V, 10 μV [Basic accuracy] ±0.0035% rdg ±5 dgt [Sampling period] FAST, MEDIUM, SLOW 0.1 s, 0.4 s, 1.0 s Temperature (°C) -10.0°C to 60.0°C, 0.1°C Allowable total line resistance ^{1) 3)} (error detection) 3 mΩ, 10 mΩ, 100 mΩ SENSE line: 10 Ω, 15 Ω, 50 Ω SOURCE line: 1.5 Ω, 4 Ω, 45 Ω
		30 mΩ	31.000 mΩ, 1 μΩ, 100 mA	31.000 mΩ, 1 μΩ, 100 mA	
		300 mΩ	310.00 mΩ, 10 μΩ, 10 mA	310.00 mΩ, 10 μΩ, 10 mA	
		3 Ω	3.1000 Ω, 100 μΩ, 1 mA	3.1000 Ω, 100 μΩ, 1 mA	
		30 Ω	31.000 Ω, 1 mΩ, 100 μA	31.000 Ω, 1 mΩ, 100 μA	
	Max. display, resolution, measurement current	300 Ω	310.00 Ω, 10 mΩ, 10 μA	310.00 Ω, 10 mΩ, 10 μA	
		3 kΩ	3.1000 kΩ, 100 mΩ, 10 μA	3.1000 kΩ, 100 mΩ, 10 μA	
	Basic accuracy	3 mΩ range	±0.5% rdg ±10 dgt ⁸⁾	±0.5% rdg ±10 dgt	
		30 mΩ range or more	±0.5% rdg ±5 dgt ⁸⁾	±0.5% rdg ±5 dgt	
	Voltage measurement ranges	6 V	N/A	6.000 00 V, 10 μV	
10 V		9.999 99 V, 10 μV	N/A		
60 V		N/A	60.000 0 V, 100 μV		
100 V		99.999 9 V, 100 μV	N/A		
300 V		N/A	300.000 V, 1 mV (BT3563-01 only)		
Max. display, resolution	1000 V	1100.00 V, 1 mV ⁹⁾	N/A		
Basic accuracy		±0.01% rdg ±3 dgt ⁸⁾	±0.01% rdg ±3 dgt		
Response time ¹⁾		700 ms	10 ms		
Sampling period ²⁾	Ω or V	N/A, 12 ms, 35 ms, 253 ms	4 ms, 12 ms, 35 ms, 150 ms		
	EX.FAST, FAST, MEDIUM, SLOW	QV	N/A, 28 ms, 74 ms, 359 ms		
Allowable total line resistance ^{1) 3)} (error detection)	SENSE line	3 Ω, 3 Ω, 20 Ω, 20 Ω	2 Ω, 2 Ω, 15 Ω, 15 Ω		
	Ranges: 3 mΩ, 30 mΩ, 300 mΩ, 3 Ω	SOURCE line	3 Ω, 3 Ω, 20 Ω, 200 Ω	2 Ω, 2 Ω, 15 Ω, 150 Ω	
Open terminal voltage	Ranges: 30 mΩ or less, 300 mΩ, 3 Ω or more	25 V, 7 V, 4 V peak	25 V, 7 V, 4 V peak		
Interface	LAN (TCP/IP, 10BASE-T/100BASE-TX)	N/A	N/A		
	RS-232C ⁴⁾ (Max. 38400 bps)	YES	YES		
	USB	N/A	N/A		
	GP-IB	YES	YES		
	EXT I/O (37-pin Handler interface)	YES	YES		
	Analog output (DC 0 V to 3.1 V)	YES	YES		
Function	Contact check	YES	YES		
	Zero adjustment (±1000 counts)	YES	YES		
	Measurement current pulse output	YES	YES		
	Comparator	Hi/ IN/ Lo	Hi/ IN/ Lo		
	Statistical calculations	Max. 30,000	Max. 30,000		
	Delay	YES	YES		
	Average	2 to 16 times	2 to 16 times		
	Panel saving/loading	126	126		
	Memory storage	400	400		
	LabVIEW [®] driver ⁵⁾	N/A	YES		
Applicable standards	Safety: EN61010 EMC: EN61326 Class A	Safety: EN61010 EMC: EN61326 Class A	Safety: EN61010 EMC: EN61326 Class A	Safety: EN61010 EMC: EN61326 Class B	
Effect of radiated radio-frequency electromagnetic field	Resistant ⁶⁾	Resistant ⁶⁾	Resistant ⁶⁾	Resistant (3 V/m)	
Effect of conducted radiofrequency electromagnetic field	10 V	N/A	N/A	N/A	
	3 V	Resistant	Resistant	Resistant	
CE	YES	YES	YES	YES	
CSA ⁷⁾	N/A	YES	N/A	N/A	
Dimensions • Weight	215W × 80H × 329D mm (8.46W × 3.15H × 12.95D in) 2.6 kg (91.71 oz)	215W × 80H × 295D mm (8.46W × 3.15H × 11.61D in) 2.4 kg (84.66 oz)	330W × 80H × 293D mm (13.00W × 3.15H × 11.54D in) 3.7 kg (130.51 oz)	199W × 132H × 60.6D mm (7.83W × 5.20H × 2.39D in) 960 g (33.86 oz)	

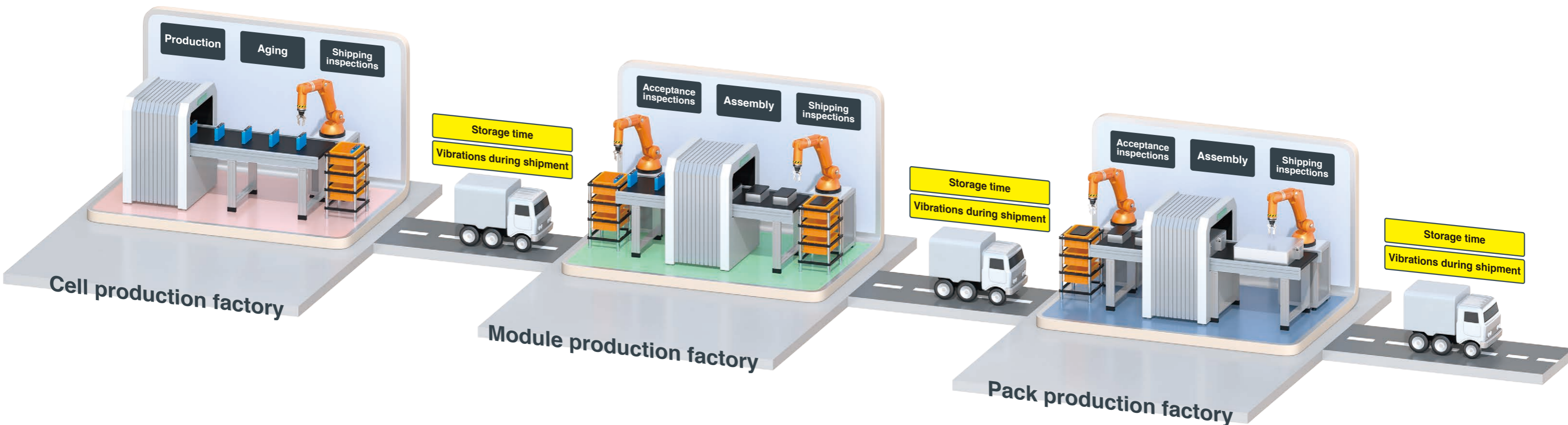
⁸⁾: Average function: When set to ON 4 times ⁹⁾: Resolution 10 mV for 1000.00 V or more ¹⁰⁾: -50: Instrument only, -51: 9465-10 bundle, -52: L2020 bundle
¹¹⁾: Zero-adjustment range R: ±0.1000 mΩ (3 mΩ range), ±0.3000 mΩ (10 mΩ range), ±3.000 mΩ (100 mΩ range), X: ±1.5000 mΩ (Common for all ranges), V: ±0.10000 V

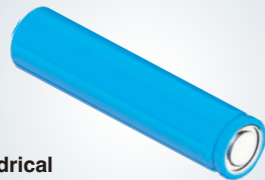
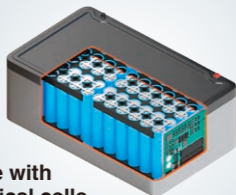
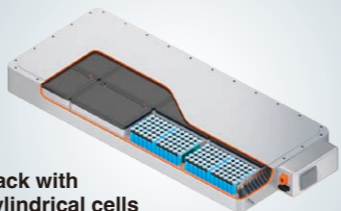
Measuring battery performance and safety

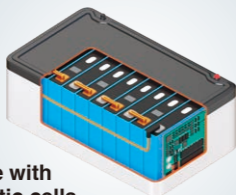
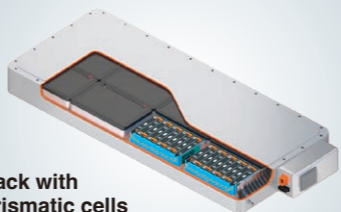

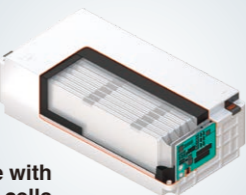
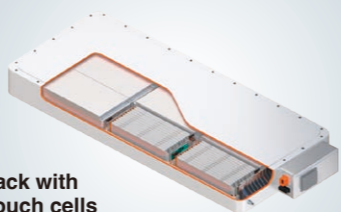
Cell production plant	Module assembly	Pack assembly
 Cylindrical cell	 Module with cylindrical cells	 Pack with cylindrical cells
 Prismatic cell	 Module with prismatic cells	 Pack with prismatic cells
 Pouch cell	 Module with pouch cells	 Pack with pouch cells

Measuring battery performance and safety using internal resistance (AC-IR) and open-circuit voltage (OCV)

Testing plays an important role in production processes by allowing plants to manufacture safe, high-performance batteries. During shipping and acceptance inspections, technicians assess battery performance by measuring internal resistance and safety by measuring open-circuit voltage.

Our Battery testers meet these needs...

“We want to manufacture batteries with stable performance.”

“We want to manufacture highly safe batteries.”

Assembly process (from cell batteries to pack batteries)

Cells produced at the cell production factory are shipped to the module production factory after undergoing a shipping inspection. Since factors such as vibrations during shipment and even the passage of time can cause defects, batteries undergo an acceptance inspection before being assembled into modules and packs.

Acceptance/shipping inspections

3561, 3561-01, BT3561A, BT3562A, BT3563A, BT3564, BT3562-01, BT3563-01, BT4560

Measuring battery performance and safety

Manufacturing batteries with stable performance

Explanation Battery quality and internal resistance (AC-IR)

High internal resistance

- More heating
- Faster degradation
- Reduced capacity

Appropriate internal resistance

- Less heating
- Slower degradation

Variations in cells' internal resistance values

Reduced overall performance for battery pack

Cell with high internal resistance

The BMS* will stop charging once the degraded cell's charge rate is 100%.

- Reduction in battery capacity due to degradation
- Battery capacity
- Amount of charge
- Charging rate

Relationship between the internal resistance and the decline of battery cell capacity

Battery cells with high internal resistance tend to generate more heat and degrade faster. When cells degrade, their capacity declines, and their internal resistance rises. Internal resistance also changes over time or as a consequence of vibrations during shipment. It's essential to eliminate cells with high internal resistance by carrying out an inspection each time cells are shipped or received.

Internal resistance and battery pack performance

It's important that all the cells in a given battery pack have uniform internal resistance. If one or more cells have high internal resistance or have degraded, they will become a bottleneck and limit the battery pack's capacity. Moreover, the battery pack's performance will rapidly decline as the BMS* attempts to protect degraded cells with reduced capacity from overcharging and over-discharging. You can improve battery cell quality by selecting cells with uniform internal resistance so that they will degrade uniformly.

*BMS: Battery Management System

Internal resistance measurement (AC-IR measurement)

3561, 3561-01, BT3561A, BT3562A, BT3563A, BT3564, BT3562-01, BT3563-01, BT4560

There are two methods for measuring a battery's internal resistance: the AC method and the DC method. Resistance values are known as AC-IR when measured using the AC method, and as DC-IR when measured using the DC method. AC-IR and DC-IR have a complementary relationship, and it's recommended to choose the one that best suits your application, or to carry out both measurements. HIOKI battery testers can perform 4-terminal AC-IR measurement.

DC method (DC-IR)

When you want to check battery performance under conditions close to actual operation

Issues with DC-IR

- Measurement takes more time.
- Measurements are less reproducible.
- Battery charges rate changes.
- Large charging and discharging equipment is required.
- The line must be capable of supplying large amounts of power.

Internal resistance = $\Delta V / \Delta I$

Connect a load and measure the resistance value based on the change in voltage and current.

AC method (AC-IR)

When you wish to identify defective products quickly and accurately, for example during shipping or acceptance inspections

Issues resolved by AC-IR measurement

- Quickly measurement with milliseconds.
- Measurements are highly reproducible.
- Battery charges rate not changes.
- Testing can be carried out with compact equipment in an energy-saving manner.

Apply the measurement current at a measurement frequency of 1 kHz and calculate the battery's internal resistance from an AC voltmeter's voltage value.

$V_s = \text{Internal resistance} \times I_s$

Two standards on LIB performance testing, IEC 61960-3/JIS C8711 (for compact equipment) and IEC 62620/JIS C8715-1 (for industrial equipment), describe how to measure internal resistance using the AC method (AC-IR). The method is also used in manufacturing processes for automotive LIB cells, which are required to deliver high levels of performance and safety.

Low-resistance measurement (1 mΩ and lower) for large batteries

BT4560

The larger the battery, the lower its internal resistance. Large batteries used in automobiles and infrastructure applications sometimes have internal resistance values of less than 1 mΩ. The BT4560's four-terminal-pair measurement method, which reduces the effects of induction fields, is an optimal solution for accurately measuring such low resistance levels.

The induction field can cause some measurement error.

Measurement using the four-terminal method, which is susceptible to the effects of induction fields

- magnetic flux generated by measurement current
- magnetic flux generated by eddy current
- external magnetic flux

BT4560

Stable, high-precision measurement using the four-terminal-pair method

The effects of induction fields can be reduced by applying a current that flows in the opposite direction as the measurement current in order to limit magnetic flux.

Measuring battery performance and safety

Manufacturing highly safe batteries

Explanation Internal shorts and open-circuit voltage (OCV)

Mechanism that causes battery fires

Internal shorts

Insulation defects, which can be caused by factors such as ageing and vibrations during shipment, can lead to fire and other dangerous accidents, making it necessary to check open-circuit voltage values in order to distinguish between defective and non-defective products.

Open-circuit voltage (OCV)

The battery voltage when no load is connected is known as the open-circuit voltage (OCV). When an insulation defect such as an internal short occurs inside the battery, self-discharge causes the open-circuit voltage to decrease.

Dendrite or contaminated metal (Dendrite: Metals precipitated dendritic form)

Open-circuit voltage (OCV)

3561, 3561-01, BT3561A, BT3562A, BT3563A, BT3564, BT3562-01, BT3563-01, BT4560, DM7276

Since the amount of change in OCV caused by self-discharge is extremely small, it is necessary to age batteries at least 100 to 400 hours before testing can accurately distinguish between non-defective and defective products. Additionally, it is necessary to measure OCV multiple times during the aging process. Using an instrument with good accuracy makes it possible to remove defects from the testing line earlier in the process, significantly reducing management and testing costs.

Dendrites form over time as minuscule metal fragment contaminants dissolve, leading to internal shorts.

High-accuracy OCV measurement

3561, 3561-01, BT3561A, BT3562A, BT3563A, BT3564, BT3562-01, BT3563-01, BT4560, DM7276

Model	BT356x series	BT4560	DM7276 (DC VOLTMETER)
Appearance			
Recommended range for 4 V measurement	6 V range	5 V range	10 V range
Number of digit, Max. Display	5 1/2 digit, 6,000.00	5 1/2 digit, 5,100.00	7 1/2 digit, 12,000.000
Resolution ¹⁾	10 μV	10 μV	1 μV
Basic accuracy ¹⁾	±0.01% rdg ±3 dgt	±0.0035% rdg ±5 dgt	±0.0009% rdg ±12 μV
Measurement error ^{1) 2)}	±430 μV	±190 μV	±48 μV
Period of accuracy guarantee	1 year	1 year	1 year
Temperature measurement	N/A	YES	YES
Temperature Compensation Function	N/A	N/A	YES

¹⁾ When using recommended range for 4 V measurement ²⁾ When measuring a 4 V LIB cell

OCV fluctuates with the ambient temperature

A battery's OCV value can fluctuate several hundred microvolts with a change of just 1°C in the ambient temperature. Temperature correction functionality allows the instrument to display a value that has been converted to the voltage at the reference temperature.

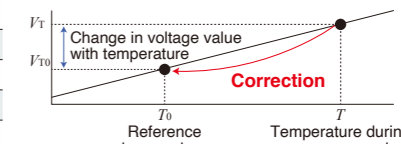

$$V_{T0} = \frac{V_T}{1 + \alpha_{T0}(T - T_0)}$$

Integrate to automatic testing system

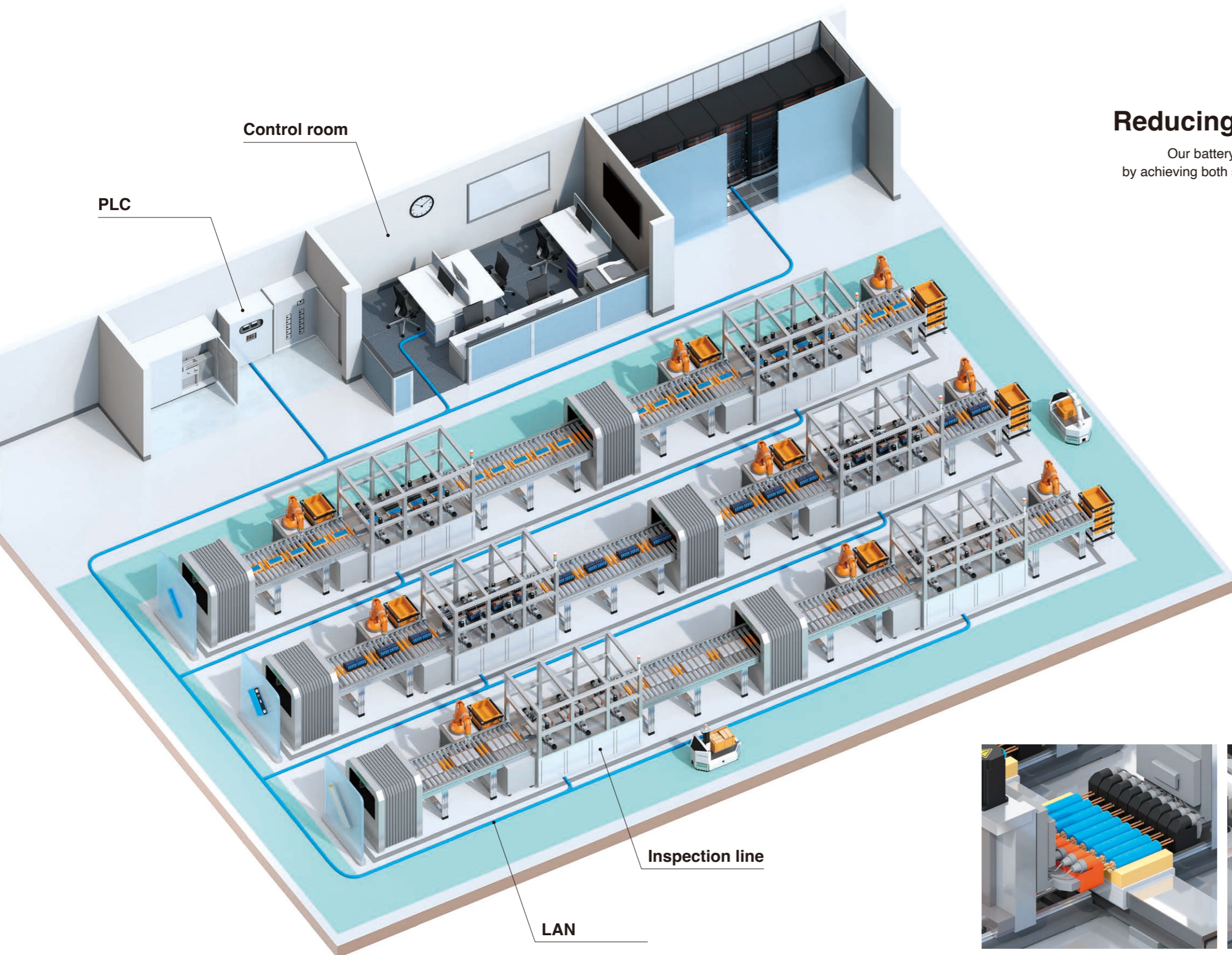

Lowering production costs Reducing downtime and shortening test times

Our battery testers resolve issues manufacturers face when they build production systems by achieving both stable, high-precision measurements and reduction of downtime and test times.

Our Battery testers meet these needs...

“We want to reduce system development cost and management man-hours.”

“We want to increase productivity by shortening test times.”

Examples

- Reducing downtime caused by measurement errors
- Reducing downtime caused by instrument malfunctions
- Lengthening the probe replacement cycle
- Controlling instruments with embedded relays
- Establishing long measurement cable runs
- Using thinner wires for measurement cables
- Connecting a PLC to a testing line via LAN
- Using multiple instruments simultaneously
- Increasing the number of test channels

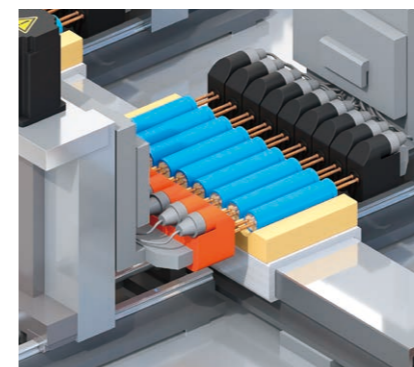

Testing of cylindrical cells

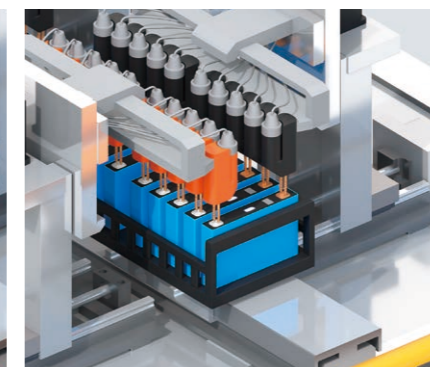

Testing of prismatic cells

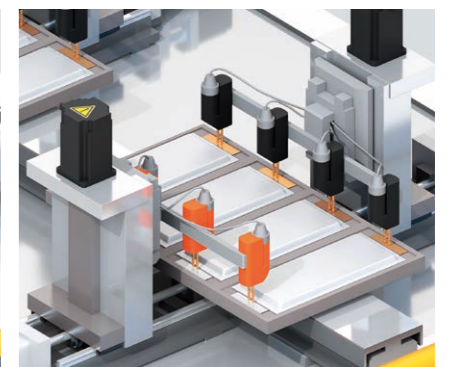

Testing of pouch cells

Acceptance/shipping inspections

3561, 3561-01, BT3561A, BT3562A, BT3563A, BT3564, BT3562-01, BT3563-01, BT4560

Integrate to automatic testing system

Reducing test system development cost and management man-hours

Explanation Line resistance and measurement current, line resistance and leakage current

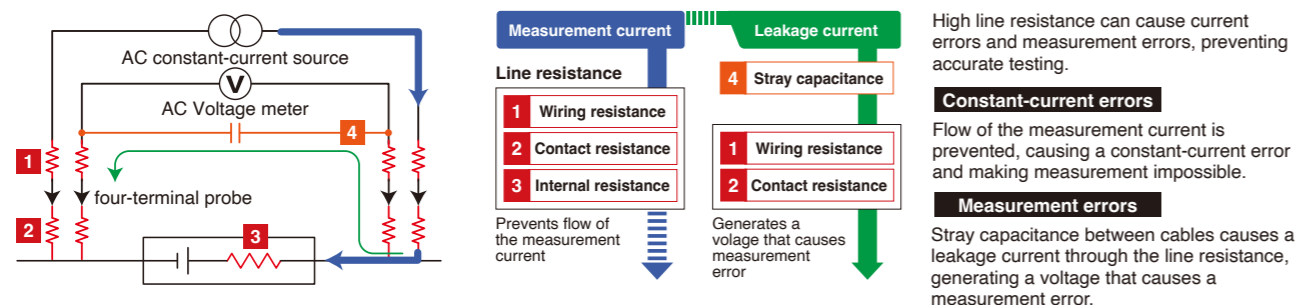

Explanation Line resistance: causes and issues

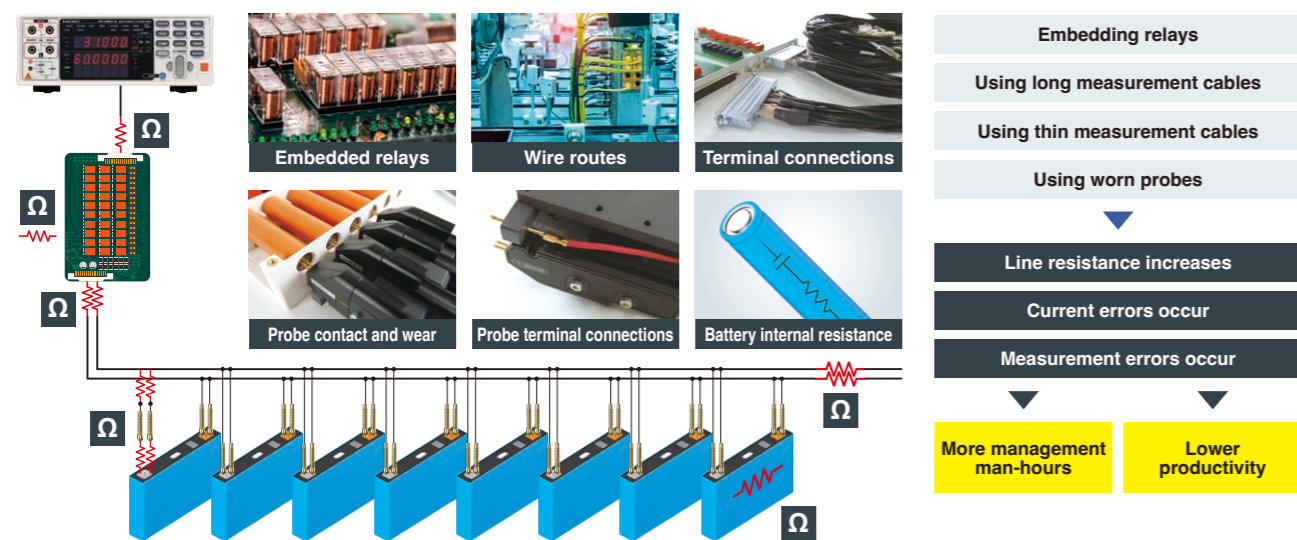

Increasing line resistance tolerances

BT3561A, BT3562A, BT3563A

The new BT356xA has dramatically improved tolerances for line resistance compared to previous models. This improvement makes it easy to build test systems with large numbers of channels using relays. Additionally, a longer maintenance cycle for systems in use means fewer maintenance man-hours. Finally, its capability to handle thinner cables than with previous models³ makes it easier to route cables.

(SENSE side when using 3 mΩ or 30 mΩ range)

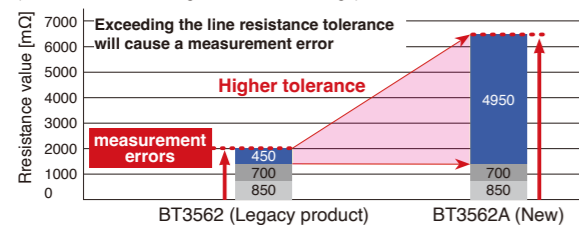

- Margin before threshold at which a measurement error occurs
- Line resistance of relay circuit (SW1001 + SW9001)
- Line resistance of 4 m measurement cable (When using AWG 25 cable) (AWG 25: 0.162 mm²)

Issues resolved by improved tolerance

- More relay options
- Able to use longer measurement cables³
- Able to use thin measurement cables³
- Fewer probe replacements

Model	3561, 3561-01				BT3561A				BT3562A, BT3563A				BT3562-01, BT3563-01, BT3564			
Range	3 mΩ	30 mΩ	300 mΩ	3 Ω	3 mΩ	30 mΩ	300 mΩ	3 Ω	3 mΩ	30 mΩ	300 mΩ	3 Ω	3 mΩ	30 mΩ	300 mΩ	3 Ω
Measurement current	N/A	N/A	10 mA	1 mA	N/A	100 mA	10 mA	1 mA	100 mA	100 mA	10 mA	1 mA	100 mA	100 mA	10 mA	1 mA
Allowable total line resistance (error detection) ^{1,2}	SENSE line		SOURCE line		SENSE line		SOURCE line		SENSE line		SOURCE line		SENSE line		SOURCE line	
	N/A	N/A	20 Ω	20 Ω	N/A	6.5 Ω	30 Ω	30 Ω	6.5 Ω	6.5 Ω	30 Ω	30 Ω	2 Ω	2 Ω	15 Ω	15 Ω
	N/A	N/A	50 Ω	500 Ω	N/A	5.5 Ω	15 Ω	150 Ω	5.5 Ω	5.5 Ω	15 Ω	150 Ω	2 Ω	2 Ω	15 Ω	150 Ω

¹: Typical value ²: Total line resistance = (Wiring resistance + Contact resistance + DUT resistance)
³: AWG 29 (0.064 mm²) wire equivalent to 2.2 Ω over an 8 m round trip can be used with the 3 mΩ or 30 mΩ range.

Preventing instrument malfunctions caused by static electricity

BT3561A, BT3562A, BT3563A

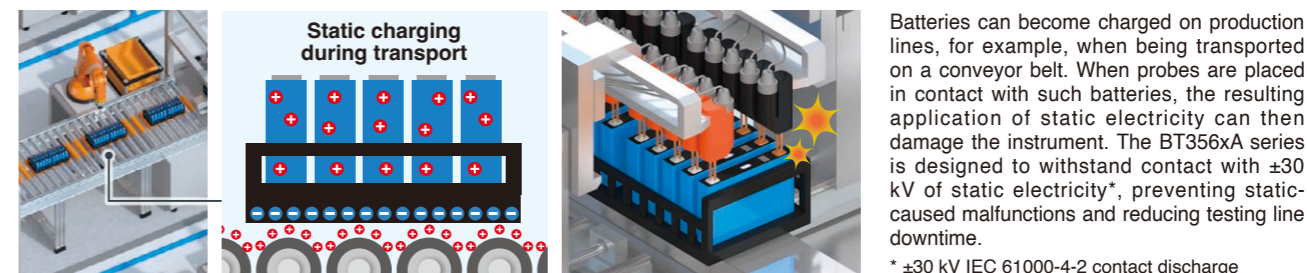

LAN interface as standard

BT3561A, BT3562A, BT3563A

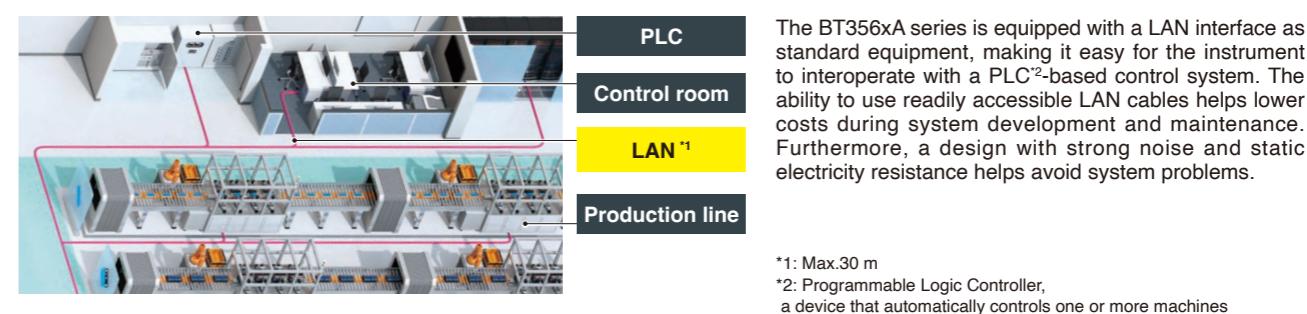

Contact check

3561, 3561-01, BT3561A, BT3562A, BT3563A, BT3564, BT3562-01, BT3563-01, BT4560



Using multiple instruments simultaneously

BT3561A, BT3562A, BT3563A, BT3564, BT3562-01, BT3563-01, BT4560

When multiple battery testers are used at the same time, their induction fields can interfere with each other, causing measurement errors. Since the instruments' measurement currents flow continuously, such interference can occur even if measurements are timed so that they don't occur simultaneously. The measurement current pulse output function allows the measurement current to flow only during measurement. By using this function to make alternating measurements, you can avoid the effects of interference between induction fields caused by the measurement current.

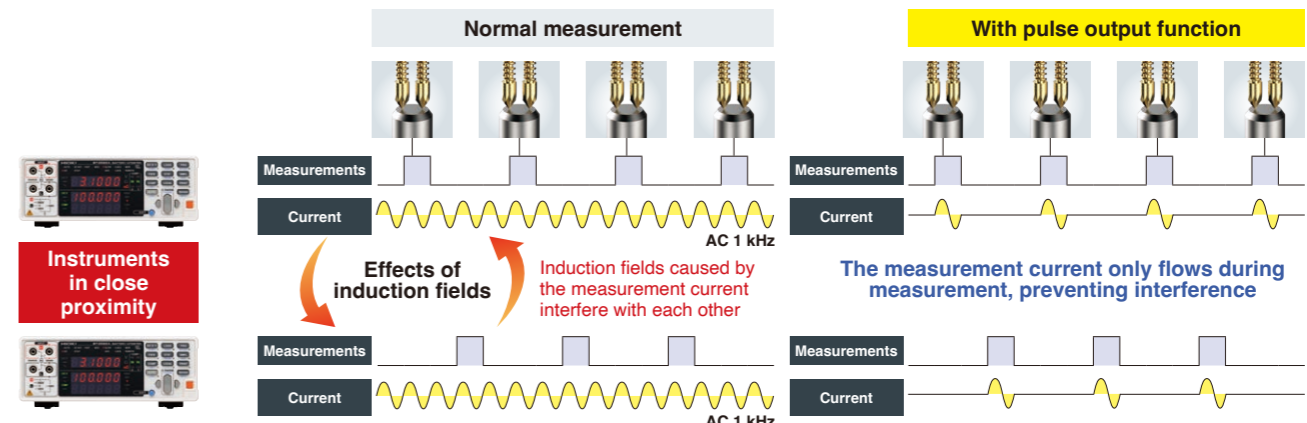

Acceptance/shipping inspections

3561, 3561-01, BT3561A, BT3562A, BT3563A, BT3564, BT3562-01, BT3563-01, BT4560

Integrate to automatic testing system

Improving productivity by reducing test times

Multiple measurement with scanner

3561, 3561-01, BT3561A, BT3562A, BT3563A, BT3564, BT3562-01, BT3563-01, BT4560

You can use the Switch Mainframe SW1001/SW1002 to increase the number of measurement channels. Additionally, you can perform scan measurement by controlling two instruments at once, for example a BT356xA series instrument and a DM7276, or a BT4560 and a DM7276.

BT356xA 132 ch

AC-IR measurement (1 kHz), OCV measurement

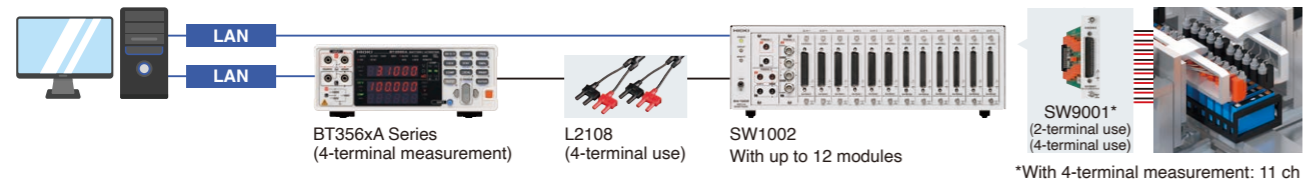

BT4560 72 ch

AC-IR measurement (frequency sweep), OCV measurement

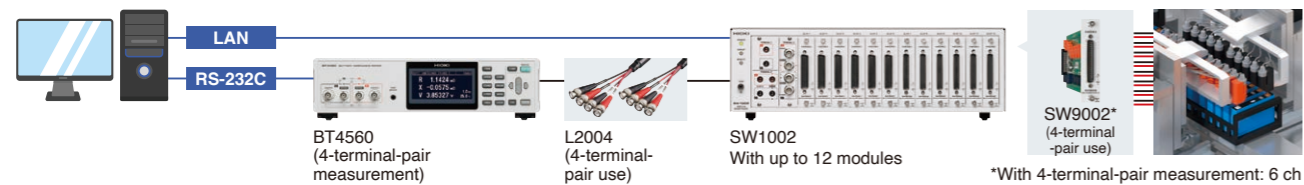

DM7276 264 ch

High-accuracy OCV measurement, Temperature Compensation Function

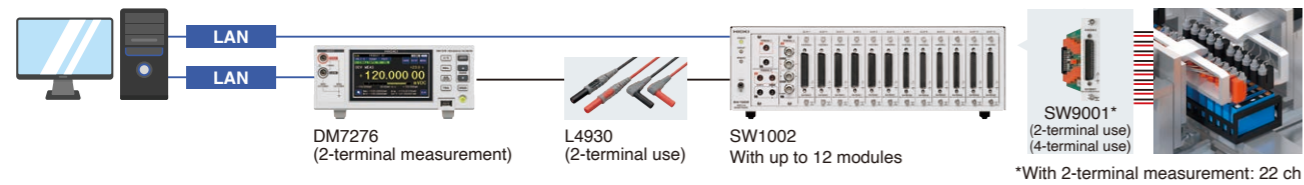

BT356xA + DM7276 132 cells

AC-IR measurement (1 kHz) and High-accuracy OCV measurement, Temperature Compensation Function

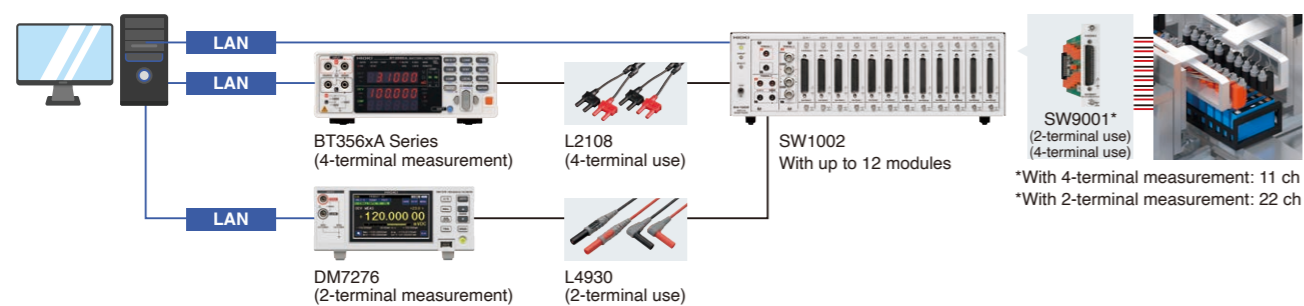

BT4560 + DM7276 72cells

AC-IR measurement and High-accuracy OCV measurement, Temperature Compensation Function

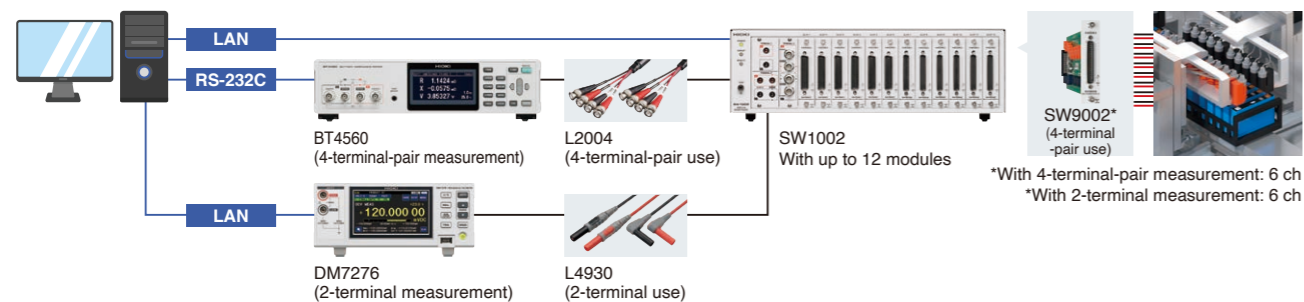

Configuration Example of Multi-channel Battery Testing

Instrument	Number of instruments in use	AC-IR measurement 1 kHz	AC-IR measurement frequency sweep	OCV measurement	High-accuracy OCV measurement Temperature Compensation Function	Connection cable	Switch mainframe	Module	Maximum number of channels
BT356xA	1	YES	N/A	YES	N/A	L2108	SW1002	SW9001	132 ch
BT4560	1	YES	YES	YES	N/A	L2004	SW1002	SW9002	72 ch
DM7276	1	N/A	N/A	N/A	YES	L4930	SW1002	SW9001	264 ch
BT356xA	2 (switched)	YES	N/A	YES	N/A	L2108	SW1002 Switching instrument	SW9001	132 ch
DM7276		N/A	N/A	N/A	YES	L4930			
BT4560	2 (switched)	YES	YES	YES	N/A	L2004	SW1002 Switching instrument	SW9002	72 ch
DM7276		N/A	N/A	N/A	YES	L4930			

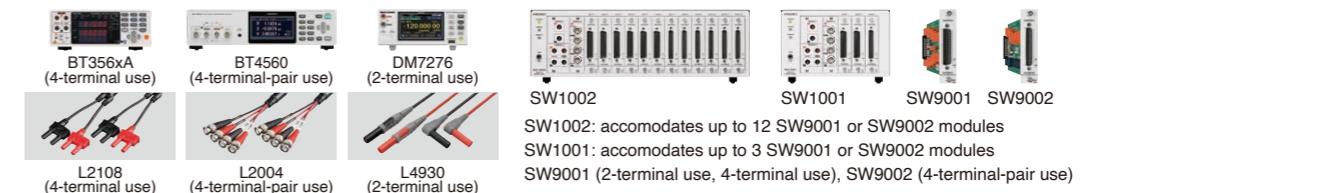

Recording results with a dedicated PC application*

3561, 3561-01, BT3561A, BT3562A, BT3563A, BT3562-01, BT3563-01, BT4560, DM7276

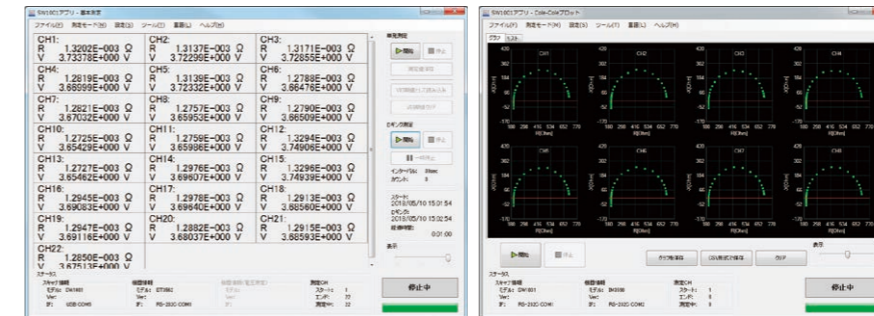

Logging function (Interval setting: 1 second to 60 minutes)

Multichannel Nyquist or Cole-Cole plot

Logging function
Measure and log up to 264 channels.

OCV measurement function
Measure OCVs, and additionally record the initial voltages and change rates as well.

Multichannel Nyquist or Cole-Cole plot
Measure impedance while varying the frequency across up to 72 channels and display the results as a Nyquist or Cole-Cole plot.

*PC application for SW1001/SW1002.

Cycle time for measurement completion

3561, 3561-01, BT3561A, BT3562A, BT3563A, BT3562-01, BT3563-01, BT4560, DM7276

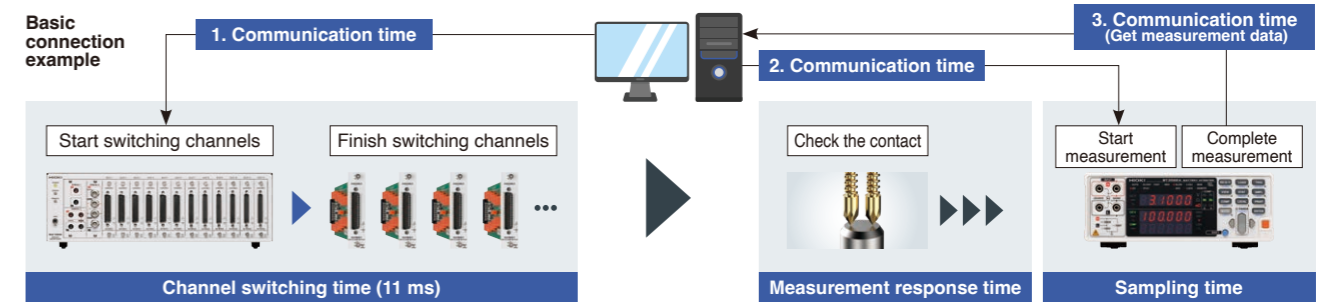



















$$\text{Cycle time calculation} \quad \text{Total time} = (\text{Communication time} + \text{Channel switching time} + \text{Measurement response time} + \text{Sampling time}) \times \text{Number of channels}$$

Instrument	Module	Number of channels	Function	Measurement speed	Measurement response time	Total time (All channels)	Conditions
BT3562A	SW9001	11	QV	EX. FAST	10 ms	0.45 s	Approx. 41 ms/ch
		11		MEDIUM	10 ms	1.1 s	Approx. 100 ms/ch
BT4560	SW9002	6	RX	FAST	0 ms	1.0 s	Approx. 167 ms/ch
		6		MEDIUM	0 ms	1.2 s	Approx. 200 ms/ch
DM7276	SW9001	22	V	0.02 PLC*	0 ms	0.45 s	Approx. 20 ms/ch
		22		FAST	0 ms	0.85 s	Approx. 39 ms/ch
		22		MEDIUM	0 ms	4.9 s	Approx. 223 ms/ch

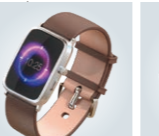
*Power Line Cycle 20 ms at 50 Hz, 16.7 ms at 60 Hz

Internal resistance and open-circuit voltage for various battery types and compatible instruments

Battery tester voltage measurement ranges	BT3564	ranges 10 V 100 V 1000 V	1000 V		EV bus 800 V to 1000 V, < 0.2 mΩ				
	BT3563A BT3563-01	ranges 6 V 60 V 300 V	400 V		Storage batteries for home use 200 V to 400 V, 0.3 mΩ to 1 mΩ		EV car 200 V to 400 V, 0.3 mΩ to 1 mΩ		
	BT3562A	ranges 6 V 60 V 100 V	230 V						
	BT3562-01 BT3561A	ranges 6 V 60 V	96 V		Forklift 72 V to 96 V, < 1 mΩ		Electric Motorcycle 48 V to 96 V, < 10 mΩ		Electric tricycle 48 V to 96 V, < 10 mΩ
	BT3562-01 BT3561A	ranges 6 V 60 V	48 V		5G base station 24 V to 48 V, < 10 mΩ		Automatic transfer robot 24 V to 48 V, < 10 mΩ		Large drones 24 V to 48 V, < 10 mΩ
	3561 3561-01 BT4560*	ranges 20 V	24 V		Power tool 12 V to 24 V, < 10 mΩ		Cleaner 12 V to 24 V, < 10 mΩ		Electric bike 24 V, < 10 mΩ
	BT4560	ranges 5 V	12 V		Tablet 3.7 V, < 10 mΩ		Smart phone 3.7 V, < 100 mΩ		Smart watch 3.7 V, < 300 mΩ
			3.7 V		Coin cell, All solid-state cell 3.7 V, < 1 Ω				

0.1 mΩ	1 mΩ	10 mΩ	100 mΩ	1 Ω
Internal resistance of battery cells				
3 mΩ 1.5 A measurement current BT4560	3 mΩ 100 mA	30 mΩ 100 mA	300 mΩ 10 mA	3 Ω - 3 kΩ 1 mA - 10 μA
Battery tester resistance measurement ranges				
BT3562A, BT3563A, BT3564, BT3562-01, BT3563-01 (3561, 3561-01: 300 mΩ, 3 Ω range) (BT3561A: 30 mΩ to 3 kΩ range)				

Testing high-voltage battery packs safely



BT3564
Max. input voltage
1000 V

The BT3564 can safely test high-voltage battery packs such as infrastructure storage batteries.

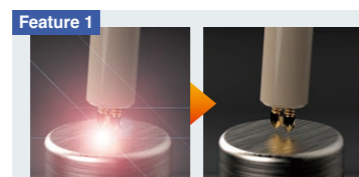

Feature 1
The instrument reduces the likelihood of spark discharges, which are prone to occur during high-voltage measurement, by limiting the amount of current that flows the instant contact is established with a battery pack.

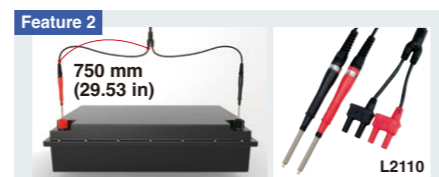

Feature 2
750 mm (29.53 in)
The optional L2110 probe, which is designed specifically for use with the BT3564, can make measurements safely thanks to its 1000 V withstand voltage. Additionally, the probe is designed to accommodate battery packs whose terminals are placed far apart.

Diagnosing degradation in batteries

BT3554-50, BT3554-51, BT3554-52

Accurately diagnosing battery degradation in an operating UPS

Measuring the battery's internal resistance and voltage to determine whether it has degraded

Our Battery testers meet these needs...

"We want to detect battery degradation in an operating UPS."

"We want to complete an intensive inspection workload efficiently."

Ensure power quality in the event of an emergency at facilities such as manufacturing plants, buildings, and datacenters.

Lead-acid or Lithium ion batteries
*BT3554-5x able to measure Lithium ion batteries.

Accurate measurement, even in a noisy environment BT3554-50, BT3554-51, BT3554-52

Inverters in operating UPS systems generate harmonic noise, and instruments usually have difficulties to make accurate measurements when affected by such noise. The BT3554-5x is able to measure accurately even when exposed to inverter noise thanks to its noise reduction technology.

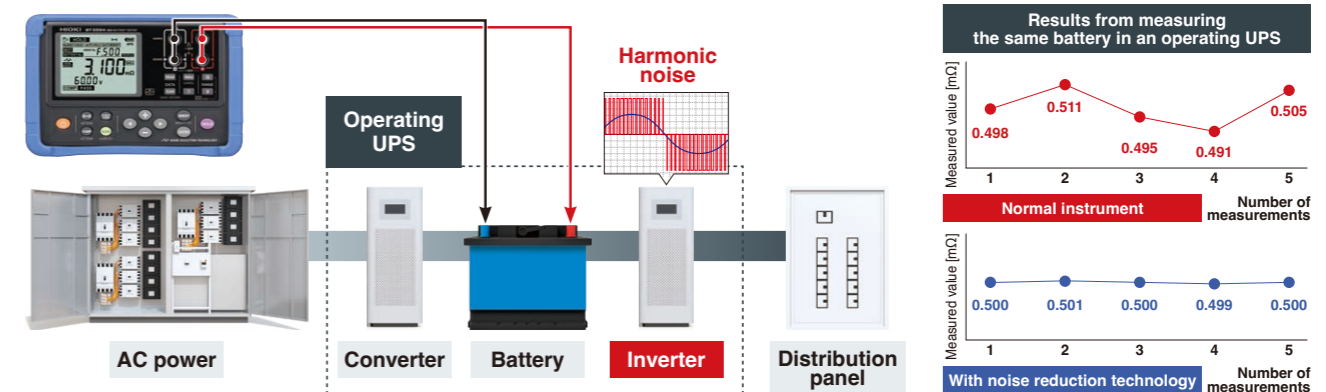

Completing an intensive inspection workload efficiently BT3554-50, BT3554-51, BT3554-52

You can efficiently inspect an enormous number of batteries, for example those found in UPS systems, with our free app "GENNECT Cross"

Register site information in advance

1 2 3 4 5 ... 500

Registration of profile information

- Location information: Office Building East Wing
- Device information: UPS for server
- Battery number: 1 to 500

[Next: battery No.1] Audio guidance indicates the next battery number to be measured.

Send measurement data

[No.1: PASS] Audio guidance indicates measurement results.

[Next: battery No.2] ... [No.2: PASS]
[Next: battery No.3] ... [No.3: PASS]
[Next: battery No.4] ... [No.4: FAIL]

Measurement data is recorded along with previously registered profile information.

Profile information	
Profile number	1
Location information	Office Building East Wing
Device information	UPS for server
Battery number	1
Measurement data	
Memory number	A.001
Data and time	2021/4/20 13:00:00
Resistance value	x.xxx mΩ
Voltage value	xx.xx V
Temperature	xx.xx°C
Comparator	x mΩ / x mΩ / x V
Threshold value	
Judgement result	PASS/WARNING/FAIL

Up to 100 sets of profile information can be registered on the BT3554-5x. Up to 500 data sets can be saved for each profile. (The BT3554-5x can save up to 6,000 data sets.)

To use GENNECT Cross, you must install the Wireless Adapter Z3210 (sold separately) and the GENNECT Cross app on your device. Profile information can be registered on the BT3554-50 from either GENNECT Cross or the desktop application GENNECT ONE.



Assessing battery characteristics with Nyquist or Cole-Cole plot

You can assess battery characteristics by analyzing Nyquist or Cole-Cole plots based on impedance values generated by frequency sweep measurement.

Our Battery testers meet these needs...

- “We want to measure impedance using the frequency sweep method.”
- “We want to assess battery characteristics with Nyquist or Cole-Cole plots.”

Assessing battery characteristics

BT4560

The chemical reactions in batteries involve several processes and each process has its own reaction speed. Therefore by sweeping the frequency and measuring the impedance the characteristics of each part can be evaluated separately.

Drawing a Nyquist or Cole-Cole plot with an impedance spectrum

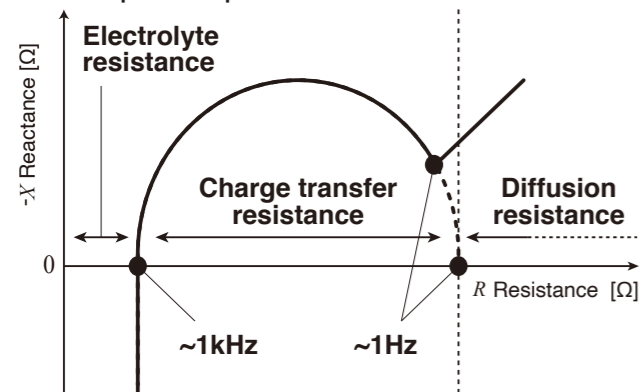

less than 1 Hz	Low frequencies	Li-ion diffusion in the electrode (Diffusion resistance)
1 Hz to several hundred Hz	Intermediate frequencies	Li-ion transfer (Charge transfer resistance)
About 1 kHz	High frequencies	Li-ion transport in electrolyte (electrolyte resistance)

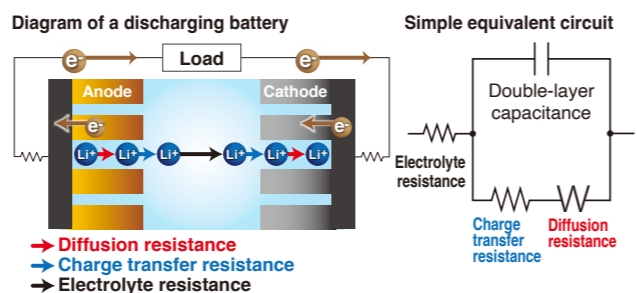

Check the battery deterioration level

The resistance of a degraded battery is significantly larger than a pristine one. The degradation of charge transfer resistance is particularly noticeable in the Nyquist or Cole-Cole plot for applications that involve charging/discharging at low temperatures or deep charging/discharging (SOC between 0% and 100%).

Compare measured data for pristine and deteriorated batteries

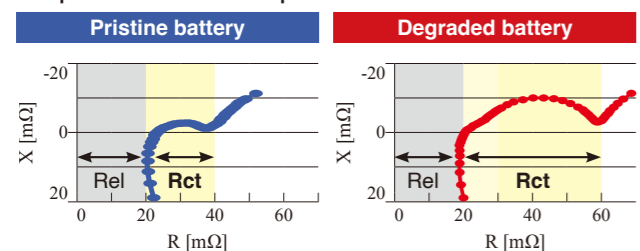

Rel: Electrolyte resistance Rct: Reaction resistance

Identify battery deterioration factors

An equivalent circuit analysis software (e.g. ZView*) can provide the parameters of each element of an equivalent circuit model by means of curve fitting. It allows you to see which part of the battery has shown characteristic changes. This serves to identify battery deterioration factors.

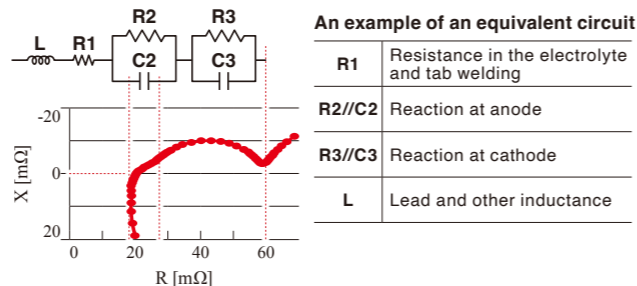

*ZView® is a product of Scribner Associates, Inc. For more information about ZView®, please contact Scribner Associates, Inc.

Measurement frequencies and low-impedance measurement

BT4560, IM3590

The BT4560 offers measurements in the optimal frequency range for liquid Li-ion batteries. Its unparalleled capability to measure extremely low impedance is ideal for large cells such as ones for xEVs or ESSs. As a complementary instrument, the IM3590 offers impedance measurements across a wider frequency range. It is very capable at measuring larger impedance.

Model	Measurement frequency	Max. Voltage	Impedance measurement ranges
BT4560 (Standard specification)	0.1 Hz to 1050 Hz	5 V	3 mΩ, 10 mΩ, 100 mΩ
BT4560 (Special specifications for 20 V)	0.1 Hz to 1050 Hz	20 V	30 mΩ, 300 mΩ, 3 Ω
BT4560 (Special specifications for 10 mHz)	0.01 Hz to 1050 Hz	5 V	3 mΩ, 10 mΩ, 100 mΩ
BT4560 (Special specifications for 20 V, 10 mHz)	0.01 Hz to 1050 Hz	20 V	30 mΩ, 300 mΩ, 3 Ω
BT4560 (Special specifications for 10 kHz)	0.01 Hz to 10 kHz	5 V	3 mΩ, 10 mΩ, 100 mΩ
IM3590	1 mHz to 200 kHz	5 V	100 mΩ to 100 MΩ

In the case battery voltage is over 20 V, please contact distributors or sales branches.



BT4560 BATTERY IMPEDANCE METER



IM3590 CHEMICAL IMPEDANCE ANALYZER

BT4560 Accuracy specifications

Impedance measurement accuracy

3 mΩ range (0.1 Hz to 100 Hz)
10 mΩ range, 100 mΩ range

$$R \text{ accuracy} = \pm(0.004 |R| + 0.0017 |X|) [\text{m}\Omega] \pm \alpha$$

$$X \text{ accuracy} = \pm(0.004 |X| + 0.0017 |R|) [\text{m}\Omega] \pm \alpha$$

$$Z \text{ accuracy} = \pm 0.4\% \text{ rdg} \pm \alpha (|\sin\theta| + |\cos\theta|)$$

$$\theta \text{ accuracy} = \pm 0.1^\circ \pm 57.3\% (|\sin\theta| + |\cos\theta|)$$

Accuracy graph

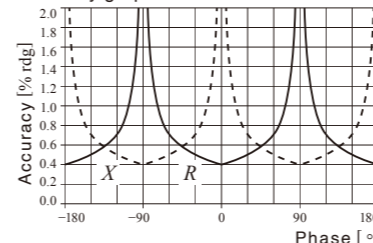

3 mΩ range (110 Hz to 1050 Hz)

$$R \text{ accuracy} = \pm(0.004 |R| + 0.0052 |X|) [\text{m}\Omega] \pm \alpha$$

$$X \text{ accuracy} = \pm(0.004 |X| + 0.0052 |R|) [\text{m}\Omega] \pm \alpha$$

$$Z \text{ accuracy} = \pm 0.4\% \text{ rdg} \pm \alpha (|\sin\theta| + |\cos\theta|)$$

$$\theta \text{ accuracy} = \pm 0.3^\circ \pm 57.3\% (|\sin\theta| + |\cos\theta|)$$

Accuracy graph

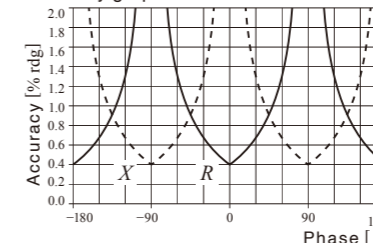

Impedance accuracy excluding α
($0.004 |R| + 0.0017 |X|$, $0.004 |X| + 0.0017 |R|$)

Impedance accuracy excluding α
($0.004 |R| + 0.0052 |X|$, $0.004 |X| + 0.0052 |R|$)

The units of R and X are [mΩ], α is as shown below

Range	3 mΩ	10 mΩ	100 mΩ
FAST	25 dgt	60 dgt	60 dgt
MED	15 dgt	30 dgt	30 dgt
SLOW	8 dgt	15 dgt	15 dgt

Temperature coefficient: $R: \pm R \text{ accuracy} \times 0.1 / ^\circ\text{C}$, $X: \pm X \text{ accuracy} \times 0.1 / ^\circ\text{C}$, $Z: \pm Z \text{ accuracy} \times 0.1 / ^\circ\text{C}$, $\theta: \pm \theta \text{ accuracy} \times 0.1 / ^\circ\text{C}$ (Applied in the ranges of 0°C to 18°C and 28°C to 40°C)

Voltage measurement accuracy (when self-calibration is performed)

V	Display range	-5.10000 V to 5.10000 V
	Resolution	10 μV
Voltage accuracy	FAST/MED/SLOW	±0.0035% rdg ±5 dgt
Temperature coefficient		±0.0005% rdg ±1 dgt / °C (applied in the ranges of 0°C to 18°C and 28°C to 40°C)

Temperature measurement accuracy (BT4560 + Z2005 temperature sensor)

Accuracy	±0.5°C (measurement temperature: 10.0°C to 40.0°C) ±1.0°C (measurement temperature: -10.0°C to 9.9°C, 40.1°C to 60.0°C)
Temperature coefficient	±0.01°C/°C (applied in the ranges of 0°C to 18°C and 28°C to 40°C)

The number of waveforms

	FAST	MED	SLOW
0.10 Hz to 66 Hz	1 wave	2 waves	8 waves
67 Hz to 250 Hz	2 waves	8 waves	32 waves
260 Hz to 1050 Hz	8 waves	32 waves	128 waves

Measurement probes and specialized jigs

Cables are also available on a special-order basis. Please contact HIOKI for more information.

Convert the BT4560's 4-terminal-pair measurement to 4-terminal measurement

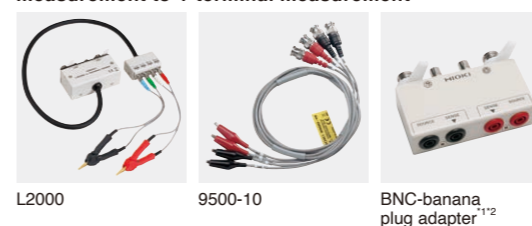

L2000 9500-10 BNC-banana plug adapter^{1,2}

Test fixture for cylindrical batteries to use with the Pin Type Probe L2003



For securing 1 cell^{2,3} For securing up to 6 cells^{2,3} With batteries attached Connection cord^{2,3} (Accommodates 18650, 21700, 4680 and 26650 size cells.)

¹: See pages 22 and 23 for compatible probes.

²: Special-order product. ³: Used when combining the BT4560 with the SW1001/SW1002 and SW9002.

Analyzing fuel cells (FCs)

BT3564-FC (Special specifications) , ALDAS-F

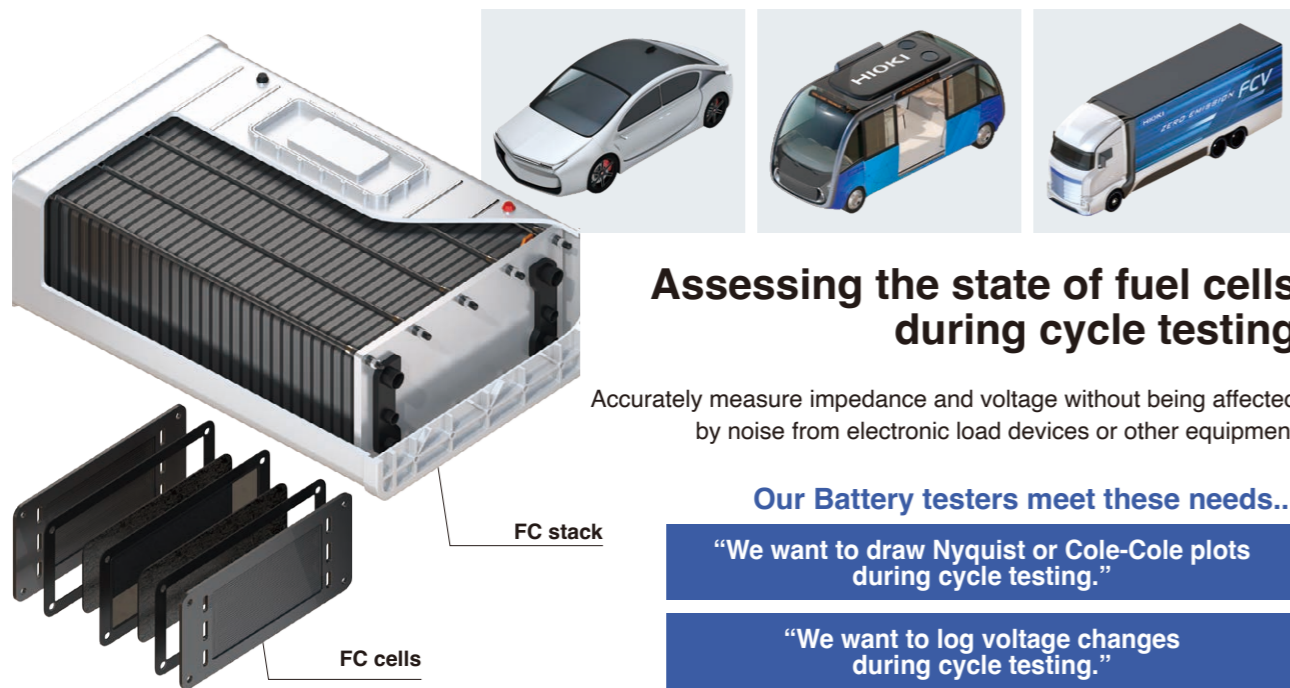

Assessing the state of fuel cells during cycle testing

Accurately measure impedance and voltage without being affected by noise from electronic load devices or other equipment

Our Battery testers meet these needs...

"We want to draw Nyquist or Cole-Cole plots during cycle testing."

"We want to log voltage changes during cycle testing."

Impedance and voltage measurement

BT3564-FC (Special specifications), ALDAS-F

Enable to draw Nyquist or Cole-Cole plots along with voltage measurement in an operating FC stack for each cells.

electronic load device with AC superposition function

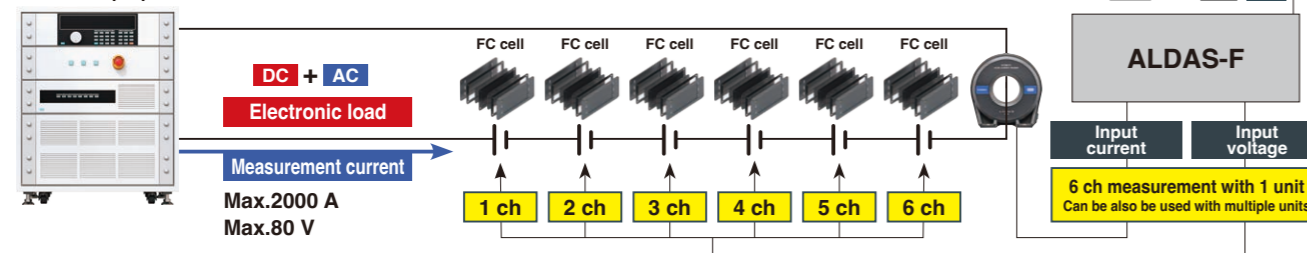

Left: Drawing Nyquist or Cole-Cole plots by the "Multi-plot" application. Right: Drawing Nyquist or Cole-Cole plots by the ALDAS-F. (Plots can be displayed for up to two channels.)

Model	BT3564-FC/BT3563-FC (Special specifications) (Not CE marked)	ALDAS-F
Measurement frequency	1 kHz	0.01 Hz to 10 kHz
Max. measurement voltage	1000 V (BT3564-FC)/300 V (BT3563-FC)	80 V
Max. allowable input current	Not specified	2000 A
Number of channels ¹	1 ch	1 ch to 6 ch (x Number of units in use)

¹: The number of channels can be increased using the SW1001/SW1002. (Maximum allowable voltage: 60 V DC)

Current sensor lineup

Appearance	Model	Rated current	Frequency characteristics	Core diameter
Pass-through type	CT6877A	2000 A	DC to 1 MHz	φ80 mm
	CT6876A	1000 A	DC to 1.5 MHz	φ36 mm
	CT6904A-2	800 A	DC to 4 MHz	φ32 mm
	CT6904A	500 A	DC to 4 MHz	φ36 mm
	CT6875A	500 A	DC to 2 MHz	φ36 mm
Clamp type	CT6846A	1000 A	DC to 100 kHz	φ50 mm
	CT6845A	500 A	DC to 200 kHz	φ50 mm
	CT6844A	500 A	DC to 500 kHz	φ20 mm
	CT6843A	200 A	DC to 700 kHz	φ20 mm
	CT6841A	20 A	DC to 2 MHz	φ20 mm



Web application "Multi-plot"

Converting measurement data into a Nyquist or Cole-Cole plot

web browser link
<https://www.circuitfitting.net/multiplot>

"Multi-plot", a free web application, enables you to draw a Nyquist or Cole-Cole plot simply by loading a file in your web browser. Supported instruments: BT4560, PW6001, IM3536, IM3570, IM3590, IM7582

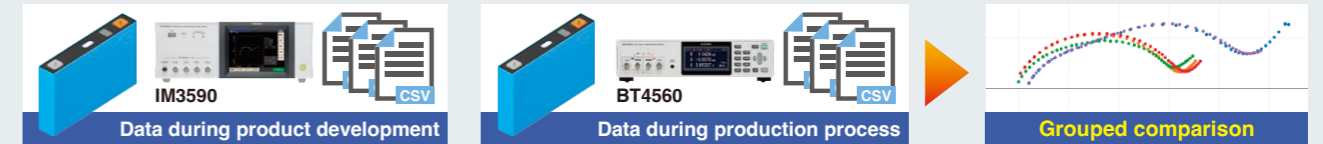

Draw Nyquist or Cole-Cole plots freely, without any limits on the number of points that can be rendered from files or the number of graphs that can be superposed. The horizontal and vertical axes are automatically scaled based on the graphs being rendered. You can even superpose, compare, and analyze files acquired using different instruments.

Loading files and superposing Nyquist or Cole-Cole plots

(You can even superpose files acquired using different instruments.)

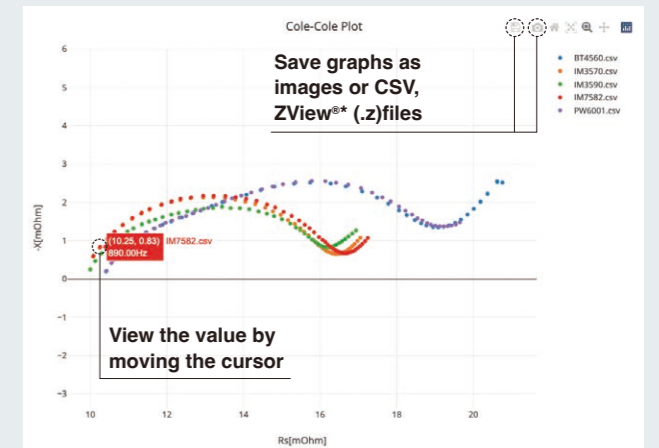
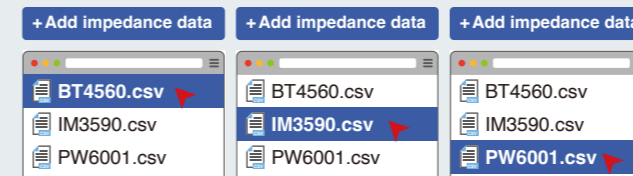

Display only the graphs you wish to compare

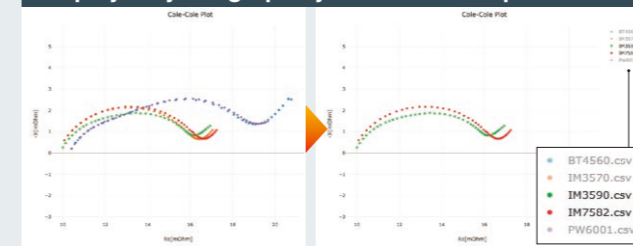

Enlarge and display a specific area

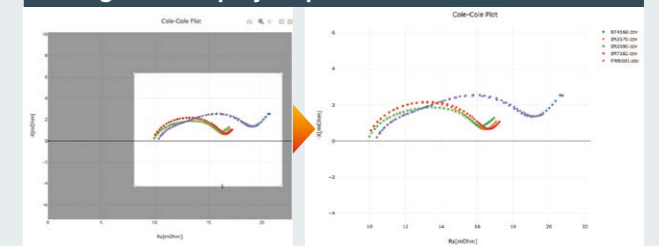

Analysis function

Conduct an equivalent circuit analysis

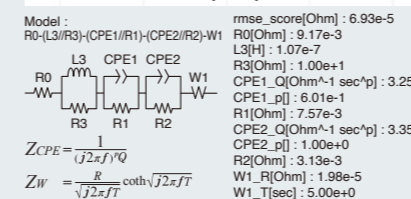
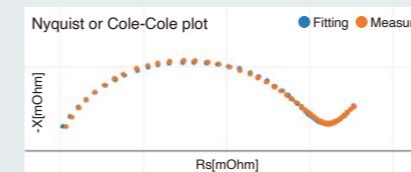

Analyze the data with predefined models. Display analysis results automatically simply by loading a file.

Draw Bode plots to assess phase characteristics

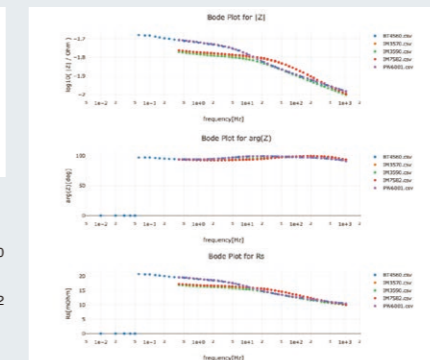

Bode plots are also drawn, enabling to assess phase characteristics.

Analyze characteristics with 3D view

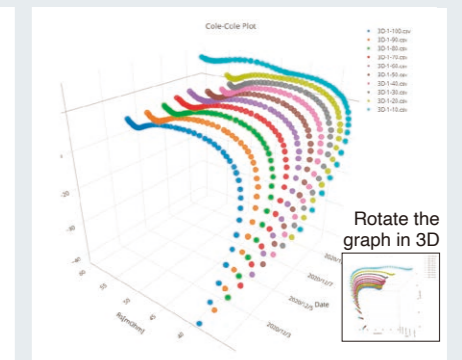

Draw 3D Nyquist or Cole-Cole plots or 3D Bode plots, using the time or date as a third axis. Rotate 3D graphs in any direction as desired and save images.

Measurement lead and measurement probe compatibility chart

- YES : Recommended measurement lead or measurement probe listed in brochures.
 N/A : Not compatible due to inability to connect.
 *1 : Not subject to accuracy guarantee.
 *2 : May be susceptible to external noise.
 *3 : BNC – banana plug adapter (See page 19)
 *4 : Connect the black banana plugs to the HCUR and HPOT terminals to reduce the influence from external noise.
 *5 : Temperature sensor cannot be connected.
 *6 : It does not use a 4-terminal-pair design, so wiring placement will have a greater effect on measured values.
 *7 : Some measurement ranges cannot be used due to rated current limitations.

Appearance	Dimensions (mm) *1	Model withstand voltage	3561 3561-01	BT3561A BT3562A BT3563A	BT3562-01 BT3563-01 BT3564	BT4560	BT3554-50
Clamps with banana plugs	131 300 56 700 56 70 15 30	9467 60 V DC (Hi-to-Lo) 60 V DC (voltage to earth)	YES	YES	YES	*1 *2 *3 *5	YES
Clamps with banana plugs	106 300 56 1500 56 200 220	9460 60 V DC (Hi-to-Lo) 60 V DC (voltage to earth)	*1 *4	*1 *4	*1 *4	*1 *2 *3 *5	YES
Clamps with banana plugs	85 188 35 630 62 MAX φ5	L2000 ±42 V peak AC+DC (Hi-to-Lo) ±42 V peak AC+DC (voltage to earth)	N/A	N/A	N/A	*6	N/A
Clamps with banana plugs	110 400 45 820 45 80 1.6 5.2	L2002 ±30 V peak AC+DC (Hi-to-Lo) ±30 V peak AC+DC (voltage to earth)	N/A	N/A	N/A	YES	N/A
Pins with banana plugs	110 400 45 820 45 80 φ1.8 9.15	L2003 ±30 V peak AC+DC (Hi-to-Lo) ±30 V peak AC+DC (voltage to earth)	N/A	N/A	N/A	YES	N/A
Clamps with banana plugs	84 130 745 85 MAX φ5	L2107 60 V DC (Hi-to-Lo) 60 V DC (voltage to earth)	YES	YES	YES	*1 *2 *3 *5	*1
Pins with banana plugs	1360 1300	9452 60 V DC (Hi-to-Lo) 60 V DC (voltage to earth)	YES	*1	*1	*1 *2 *3 *5	*1
Clamps and pins with banana plugs	280 1350 350 40 750 45 80	9453 60 V DC (Hi-to-Lo) 60 V DC (voltage to earth)	YES	YES	YES	*1 *2 *3 *5	*1
Pins with banana plugs	135.5 260 56 850 56 70 φ0.24 0.12	9455 60 V DC (Hi-to-Lo) 60 V DC (voltage to earth)	YES	*1	*1	*1 *2 *3 *5 *6	*1
Pins with banana plugs	132.5 240 56 250 56 70	9461 60 V DC (Hi-to-Lo) 60 V DC (voltage to earth)	*1	*1	*1	*1 *2 *3 *5	*1

Appearance	Dimensions (mm) *1	Model withstand voltage	3561 3561-01	BT3561A BT3562A BT3563A	BT3562-01 BT3563-01 BT3564	BT4560	BT3554-50
Pins with banana plugs	121.5 140 56 1500 56 50 φ1.27 φ2.7 φ2.9 13.5	9465-10 60 V DC (Hi-to-Lo) 60 V DC (voltage to earth)	*1	*1	*1	*1 *2 *3 *5	YES
Pins with banana plugs	140 260 46 250 56 50 φ0.6 φ1.8 2 9	9770 60 V DC (Hi-to-Lo) 60 V DC (voltage to earth)	YES	YES	YES	*1 *2 *3 *5	*1
Pins with banana plugs	138 260 46 250 56 50 0.2 2.2 9	9771 60 V DC (Hi-to-Lo) 60 V DC (voltage to earth)	YES	YES	YES	*1 *2 *3 *5	*1
Pins with banana plugs	118.2 140 56 1500 56 50 55 45 2.5 4.3 9.15	9772 60 V DC (Hi-to-Lo) 60 V DC (voltage to earth)	*1	*1	*1	*1 *2 *3 *5	YES
Pins with banana plugs	164 150 60 1500 60 50 φ1.27 φ2.7 φ2.9 13.5	L2020 60 V DC (Hi-to-Lo) 60 V DC (voltage to earth)	*1	*1	*1	*1 *2 *3 *5	YES
Pins with banana plugs	172 300 53 700 53 70 2.5 4.3 9.15	L2100 1000 V DC (Hi-to-Lo) 1000 V DC (voltage to earth)	*1	YES	YES	*2 *3 *5	*2
Pins with banana plugs	210 750 53 700 53 70 2.5 φ1.8 3.9	L2110 1000 V DC (Hi-to-Lo) 1000 V DC (voltage to earth)	*1	YES	YES	N/A	N/A

Appearance	Dimensions (mm) *1	Model withstand voltage	3561 3561-01	BT3561A BT3562A BT3563A	BT3562-01 BT3563-01 BT3564	BT4560	BT3554-50
Clamps with banana plugs	84 250 955 70 73 85 MAX φ5	L2101*2 60 V DC (Hi-to-Lo) 60 V DC (voltage to earth)	*2	*2	*2	*2 *3 *5	*2
Pins with banana plugs	178 250 835 70 73 85 φ0.6 φ1.8 2 9	L2102*2 60 V DC (Hi-to-Lo) 60 V DC (voltage to earth)	*2	*2	*2	*2 *3 *5	*2
Pins with banana plugs	176 250 885 70 73 85 0.2 2.2 9	L2103*2 60 V DC (Hi-to-Lo) 60 V DC (voltage to earth)	*2	*2	*2	*2 *3 *5	*2
Pins with banana plugs	350 860 70 73 280 85	L2104*2 60 V DC (Hi-to-Lo) 60 V DC (voltage to earth)	*2	*2	*2	*2 *3 *5	*2

*1: Dimensions other than overall length include typical values.

*2: HIOKI recommends measurement leads without separate guard terminals: L2101 - L2107, L2102 - 9770, L2103 - 9771, L2104 - 9453

Batteries are a driving force for a variety of innovations as we move towards a sustainable society

Batteries are used in an array of applications, and their performance can be a driving force for a variety of innovations and new lifestyles. The development and production of high-quality batteries will play an essential role as we work to realize a sustainable society. At the same time therefore, growing improvements in battery life cycle assessment have become a major priority. The focus on reducing CO2 emissions throughout the entire life cycle by means of improvements in manufacturing processes and reuse of high-quality batteries is increasing. HIOKI battery testers are helping resolve these issues through an electrical measurement approach.

Stacked battery voltage, Internal resistance of battery cells

 FCV 800 V to 1000 V, 0.2 mΩ	 EV truck 800 V to 1000 V, 0.2 mΩ	 EV bus 800 V to 1000 V, 0.2 mΩ	 EV car 200 V to 400 V, 0.3 mΩ to 1 mΩ
 Storage batteries for home use 200 V to 400 V, 0.3 mΩ to 1 mΩ	 Automatic transfer system 72 V to 96 V, 1 mΩ	 Forklift 72 V to 96 V, 1 mΩ	 5G base station 48 V, < 1 mΩ
 Electric motorcycle 48 V to 96 V, 10 mΩ	 Electric tricycle 48 V to 96 V, < 10 mΩ	 Large drones 24 V to 48 V, 10 mΩ	 Automatic transfer robot 24 V to 48 V, 10 mΩ
 Electric bike 24 V, 10 mΩ	 Power tool 12 V to 24 V, 10 mΩ	 Cleaner 12 V to 24 V, < 10 mΩ	 Laptop 7 V to 12 V, 100 mΩ
 Tablet 3.7 V, 10 mΩ	 Smart phone 3.7 V, 100 mΩ	 Smart watch 3.7 V, 300 mΩ	 Coin cell, All solid-state cell 3.7 V, < 100 mΩ

Note: Company names and product names appearing in this brochure are trademarks or registered trademarks of various companies.

HIOKI
HIOKI E. E. CORPORATION

HEADQUARTERS
81 Koizumi,
Ueda, Nagano 386-1192 Japan
<https://www.hioki.com/>



DISTRIBUTED BY