

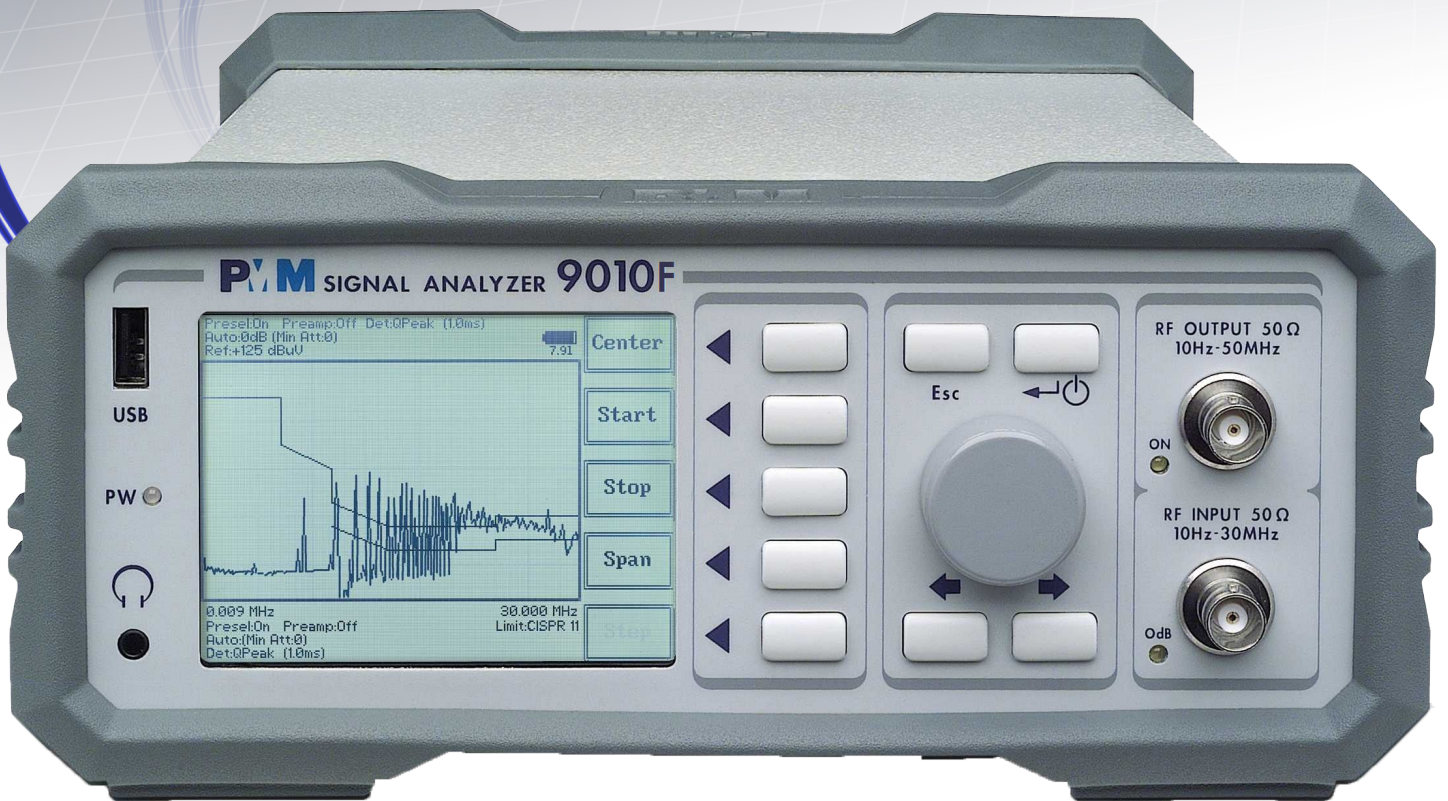

narda

Safety Test Solutions[®]

an **L3** Communications Company



9010F

Real time EMI receiver & Analyzer 10 Hz - 18 GHz
Full CISPR 16-1-1 compliant 9 kHz - 30 MHz

9010F: maximum speed at full compliance

F stands for Fast it is a powerful EMI Receiver and Analyzer fully compliant to CISPR 16-1-1 and MIL-STD-461, intended for measuring conducted and radiated disturbances from 10 Hz up to 30 MHz, and up to 3/6/18 GHz when matched with 9030/9060/9180 extension units.

The very advanced design combines electronics at the height of technology with PMM's traditional philosophy of easy, trouble-free operation to allow users focusing on measurements results instead of on the instrument itself.

In this direction, the 9010F offers outstanding performances of measurement speed always in full compliance with the relevant standards.

Disturbances Measurements

Performed according to CISPR and MIL-STD require setting a receiver or spectrum analyzer with the proper RBW filters, detectors, frequency steps as narrow as 1/4 of RBW and Hold time, or observation time, of 1, 2... up to tens of seconds for each frequency step, depending on the standards and on the disturbances nature.

Hence there are important aspects to consider:

- Incorrect settings shall result in concrete risk of under-estimating the EUT (Equipment Under Test) disturbances in reference to the limits, that means not passing the product approval for emissions.
- Correct settings imply that tests may last long time, even several hours for a single frequency scan: this may affect the EUT prototyping and approval and prolongs the time-to-market of new products.
- EUT characterized by short operation cycles like electric tools, food machinery - in general all appliances with electric motors overheating if run for too long time - could be not tested.

It's true that since the '80s PMM pioneered various methods - e.g. the Smart Detector - for minimizing the test times; however, a full range scan must always be performed as final test.

The New 9010F Overcomes All Limitations At Once:

its state-of-art digital hardware together with EMC-specific technical solutions allow for employing the FFT (Fast Fourier Transform) analysis in full compliance with the EMI receiver reference standards: CISPR 16-1-1 and MIL-STD-461.

Test time is reduced from hours to seconds.

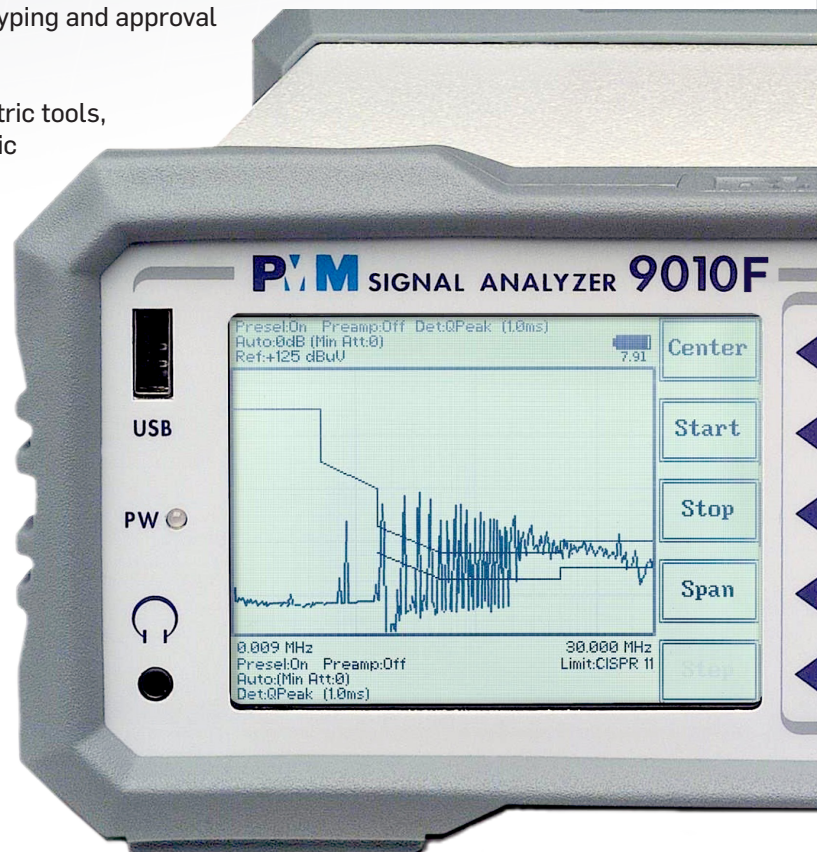

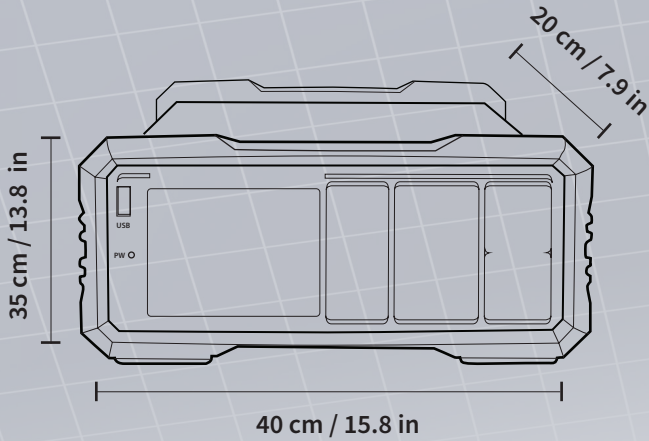

Low-consumption, bright backlit integrated LCD display featuring a sophisticated graphics processing that shows even the narrowest peak in the spectrum under measurement



“Test Time Is Reduced From Hours To Seconds.”

Revolutionary Concept

The 9010F is the first FFT-based EMI Receiver that fits in any budget and grows with your needs:

- On-field expansion to Radiated Full Compliance, 3-6-18 GHz
- Safe and easy Firmware and Software upgrading from Web
- Digital Technology for best reliability
- Reduced turnaround time and cost for periodic re-calibration
- Full choice of Ancillary Equipments
- Powerful PC Software included
- Small size, lightweight, AC/DC and battery for field tests

Unique Advantages

In all applications:

- EUT that cannot run all the test time long: appliances, electric tools, toys, machinery... the 9010F avoids pre-tests and partial final tests by performing the complete test in seconds instead.
- EMC laboratories and Test houses: the 9010F cuts conducted emission tests time down nearly to zero and greatly reduces the radiated ones, thus making the set-up available for more tests and increasing the productivity.
- On-site measurements of overhead lines: faster and safer radiocommunication interference measurements from PLT signals (RA-01HV antenna recommended)

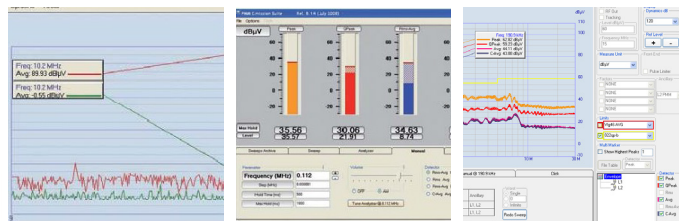
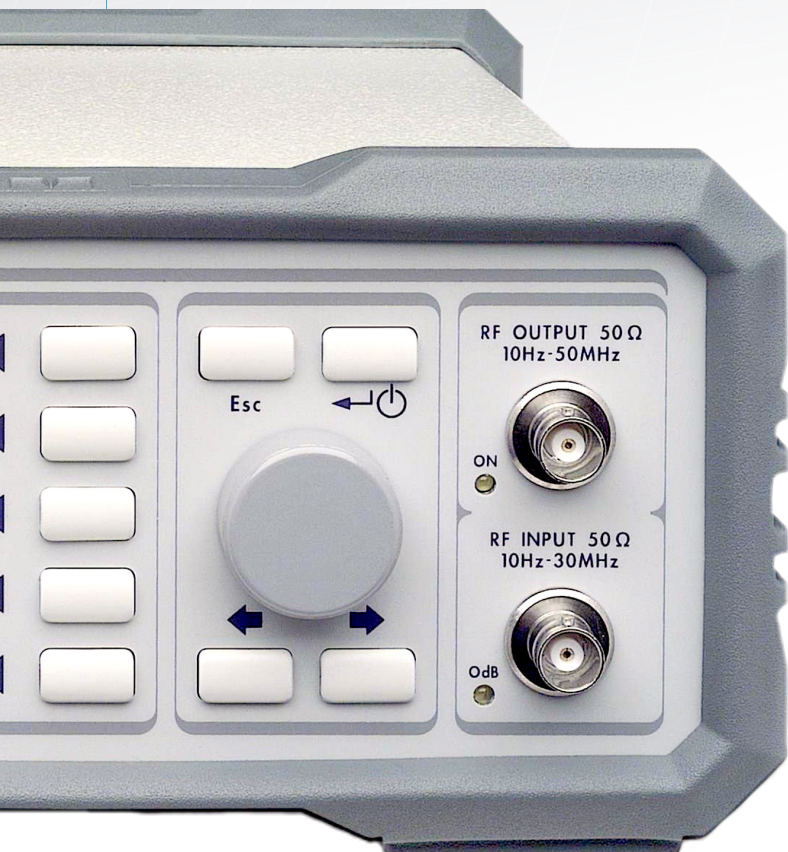

PMM Emission Suite: see pages 8/9

Operating Principle

The 9010F is a real-time, gapless, direct conversion EMI measuring receiver based on FFT (Fast Fourier Transform), a calculation process applied to a set of samples acquired in time domain, that outputs in a single shot the frequency contents of the input signals in a set frequency band.

Real time means that the FFT calculation is as fast as the incoming data are sampled, so that no data are missed in the analyzed band.

Gapless means that the consecutive time windows are sampled without time gaps between each other.

In addition, the receiver computes the RBW filters and detectors in full compliance with CISPR and MIL-STD requirements. The purpose is reducing the measurement time in reference to conventional receivers, in full compliance with CISPR and MIL-STD standards.

FFT Applied To Emi

To measure the EMI (electromagnetic interferences) with the required repeatability and uncertainty, receivers must comply to the relevant standards: CISPR 16-1-1, MIL-STD 461. The statement of full compliance implies that all the tests as prescribed by the standards have been passed, whatever technology the receiver is based on. Frequency preselection by a set of filters at the receiver input is not an option but it's essential to provide the receiver of the dynamic range required for passing all the tests, including the single pulse, thus accurate, repeatable measurements of disturbances are ensured in all circumstances. Without preselection filters, artifact signals may appear as if generated by the EUT, providing incorrect test results.

The 9010F and the frequency extension modules are all equipped of automatic frequency preselectors.

Observation Time (Hold Time), Frequency Step And Test Time

The Hold Time is the minimum time the receiver must "watch" at each frequency step: its amount varies according to the standards and to the nature of disturbances, from the minimum required by the RBW filters' settling time up to tens of seconds. Such detectors based on time integration (Quasi-peak, C-Average etc.) require the minimum hold time not to be set below a certain value, typically of one second, otherwise measurements are consistently incorrect if not meaningless.

The frequency step is the amount the receiver increases the tuning frequency: it must be lower than the RBW filter.

The test time is the total time required for scanning the frequency band. In conventional receivers the test time corresponds approximately to the number of frequency steps the band is divided in, multiplied by the Hold Time and multiplied by the number of detectors used, when not processed in parallel.

In conducted emission tests the test time shall be multiplied for the number of LISN's AC lines, e.g. 2x for single-phase and 4x for three-phase EUT.

FFT Frequency Band And Measurement Time

FFT processes several frequencies at once in a single block, whose the duration in time corresponds to the set hold time; theoretically, the wider the frequency block the shorter the measurement time. However, the required full compliance to CISPR and MIL-STD and cost per benefit considerations make the frequency band calculated by FFT not arbitrarily wide. Thanks to an optimal design based on state-of-art digital hardware, parallel processing of all detectors and high-speed digital communication with the frequency extension modules, the 9010F dramatically reduces the test time in all applications.

Direct Conversion And FFT

The 9010F is a true digital receiver: the signals are directly sampled and digitized after the RF front-end by an A/D converter of very high dynamic range, matching the severe criteria for full compliance. Within these requirements, current technology allows for direct conversion of bands up to tens of megahertz; the 9010F features the direct conversion up to 30 MHz, covering the A - B CISPR and MIL-STD 461 bands typical of conducted emission tests. Among the many advantages of this technique respect to conventional receivers, it is worth to mention the higher level of protection against overloading and possible damages. FFT is applied directly to the time-domain digitized signals.

FFT At Higher Frequencies

Extending the application to frequencies in the range of gigahertz needs changing the design in the direction of the heterodyne frequency conversion principle: after the RF front-end, signals are down-converted in the frequency range suitable for the direct analog to digital conversion as described above. Then FFT processes the whole band - e.g. 30 MHz to 3 GHz - in "blocks" where all the frequencies are calculated at once, each block corresponding to the set hold time. The blocks are then "sticked" together to obtain the whole band spectrum in much shorter time respect to a conventional scanning receiver or sweeping analyzer. Being the 9010F gapless, no signal parts are lost during the processing of each block.

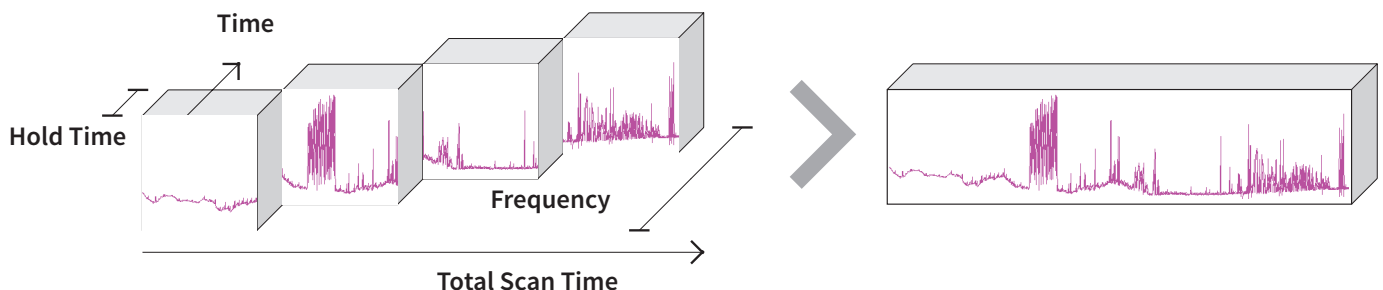

Test Time Reduction Examples

Typical full-compliance settings calculated on one single scan with 9010F driven by the PMM Emission Suite(*)

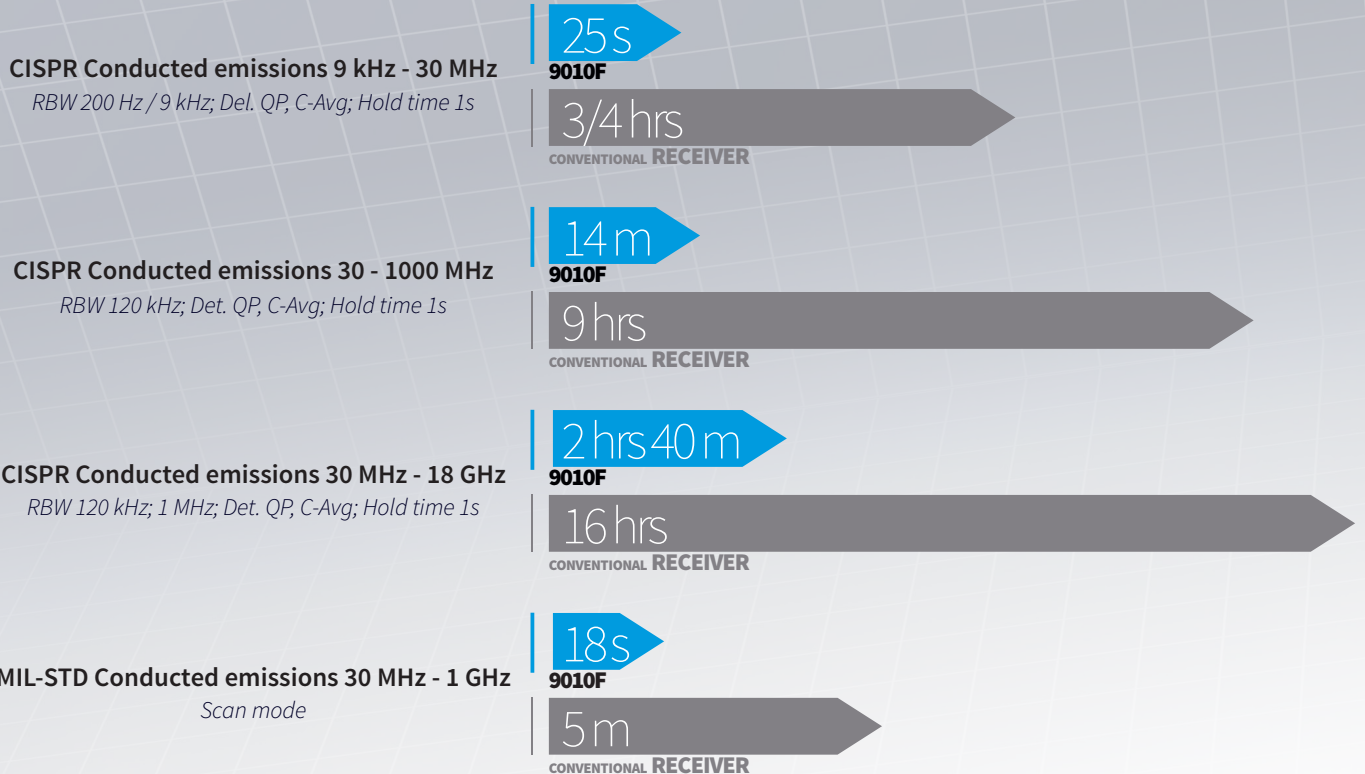

PMM's Frequency Extension Modules: unique advantages

The Frequency Extension Modules are real EMI receivers of unique design offering the following outstanding features:

- Connect-and-go operation
- Designed for operation inside to the chamber
- Very compact size and lightweight
- Long-lasting plug-in rechargeable Li-Ion battery
- Direct connection to many antennas
- Digital fiber optic link up to 100 m
- Internal preselector, preamplifier and auto-attenuator
- Full CISPR and MIL-STD compliance
- Improved measurement uncertainty and dynamic range

Available Models

- 9030: 30 MHz - 3 GHz
- 9060: 30 MHz - 6 GHz
- 9180: 6-18 GHz

Replacing the coaxial cable by a fiber optic carrying only digital signals totally avoids the cable and connectors losses at the benefit of the sensitivity and dynamic range, particularly at the higher frequencies. In addition other unwanted effects of the cable are avoided: scattering, non-linearity, aging, mechanical and installation limitations.

The internal preamplifier - standard on all models - further reduces the uncertainty sources to take into account.

Specific adapters allow for an easy installation on the back of different types of antennas, tripods, masts etc.

Technical specifications are described in the following pages.

The frequency extension modules can be purchased any time, separately from the main unit 9010F.

(*) Above examples are indicative for receiver settings (CISPR RBW filters and detectors, hold time according to the different bands; preselection and autoranging) as prescribed by generic and product standards for fully compliant tests; figures may vary if other settings are used.

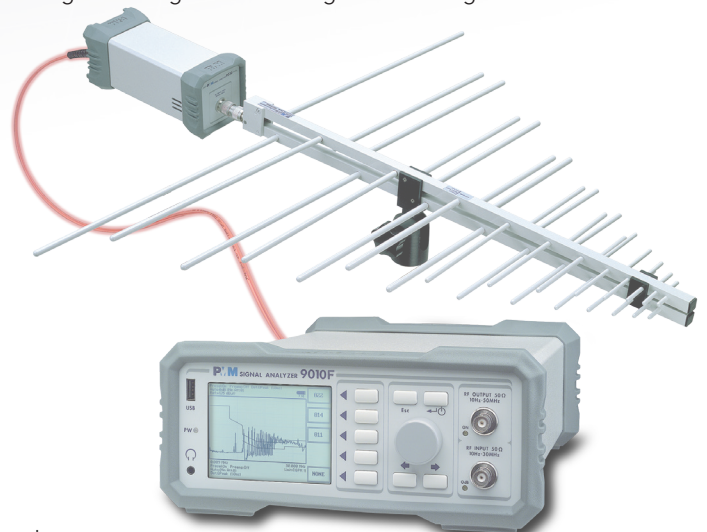

Unique Applications

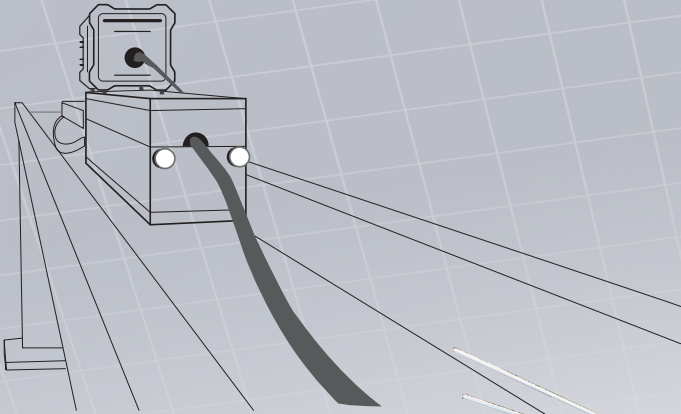

The set of mounting adapters supplied with PMM's Receiver Modules is suitable for several types of antennas: its special design avoids mechanical stress to the RF connectors and allows for an easier installation on the antenna pole.

Easier Radiated Power set-up

The high frequency receiver module can be mounted directly on top of the EM Clamp with just a very short cable connection.

Replacing the usual, long coaxial cable by the fiber optic offers concrete advantages: an easier clamp displacement, no cable pick-up noise, no influence from nearby walls and structures.

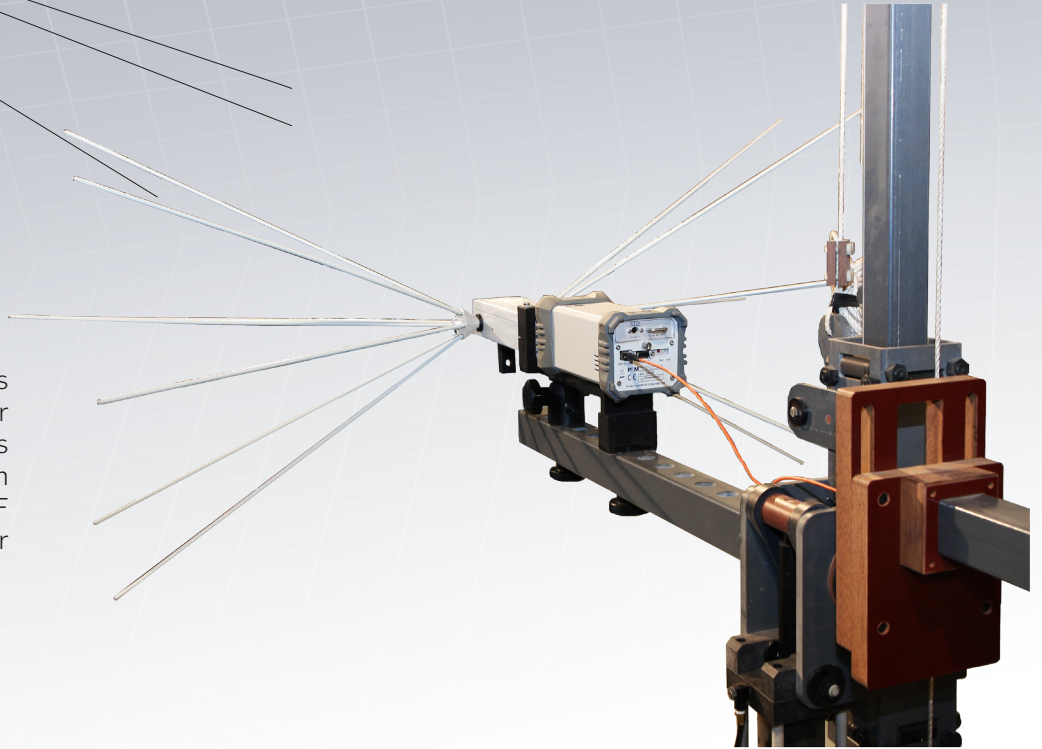

IEC/EN 55015: radiated measurement with the Large Loop Antenna easier and faster than never thanks to the high-speed of 9010F in conjunction with the RF switch SBRF4 automatically switching the x-y-z axis.

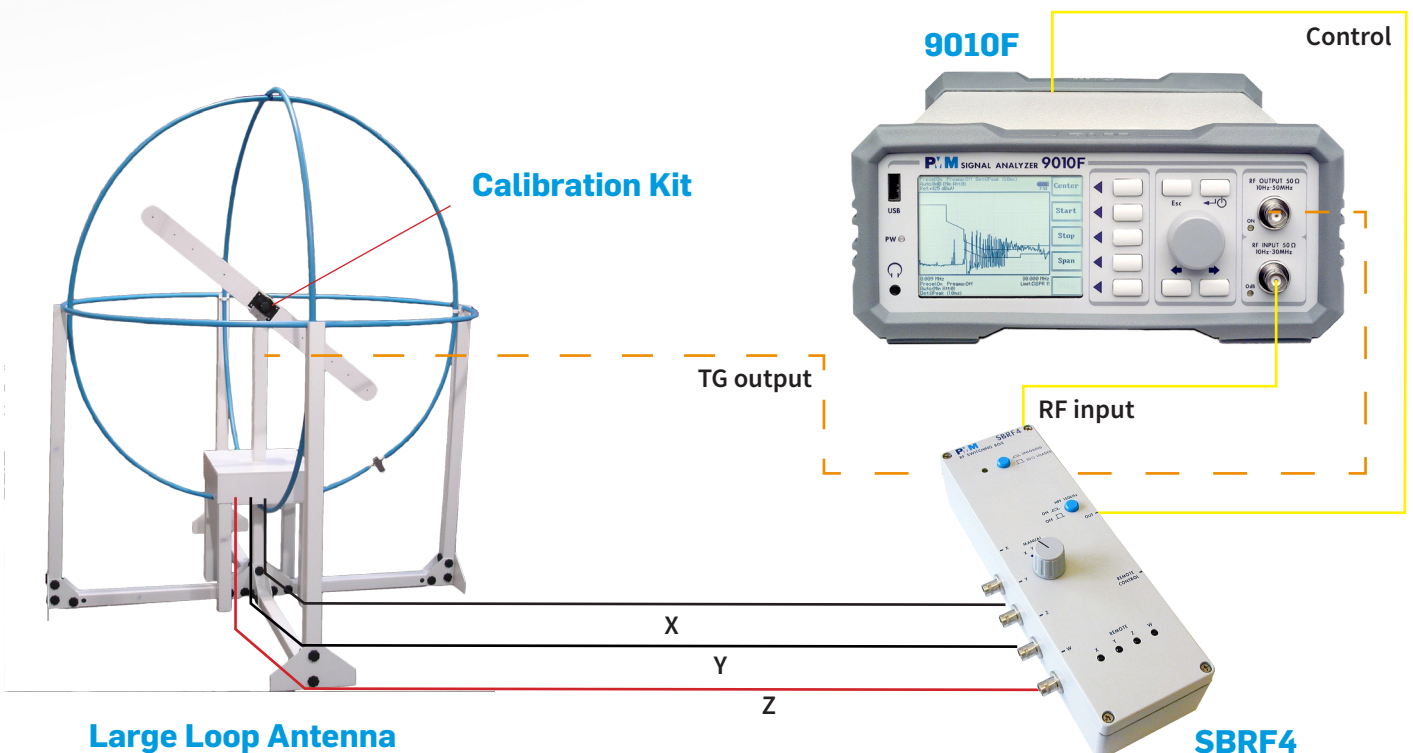

Pre-Testing And Debugging

In most of the cases, measurements in full compliance mode (Sweep mode) are performed by the the 9010F so rapidly to satisfy the requirements of investigating and debugging the EMI issues of an EUT before the final qualification test. If needed, when in Analyzer mode the 9010F can feature its maximum speed capabilities by automatically optimizing the settings in a spectrum analyzer-like operation:

Frequency Band	Settings	Sweep Time
9 kHz - 30 MHz	RBW: 300 kHz Hold time: 1s	1 s (*)
	RBW: 10 (9) kHz Hold time: minimum, auto	0,4 s (**)
	RBW: 3 kHz Hold time: minimum, auto	1,3 s (**)
30 MHz - 1 GHz	RBW: 120 kHz Hold time: minimum, auto	2 s (**)
1 - 6 GHz	RBW: 1 MHz Hold time: minimum, auto	5 s (**)
6 - 18 GHz	RBW: 1 MHz Hold time: minimum, auto	13

(*) Real-time analysis: 1 s hold time takes just 1 s

(**) Gapless time domain acquisition

Spectrum Analyzer Mode Screenshot

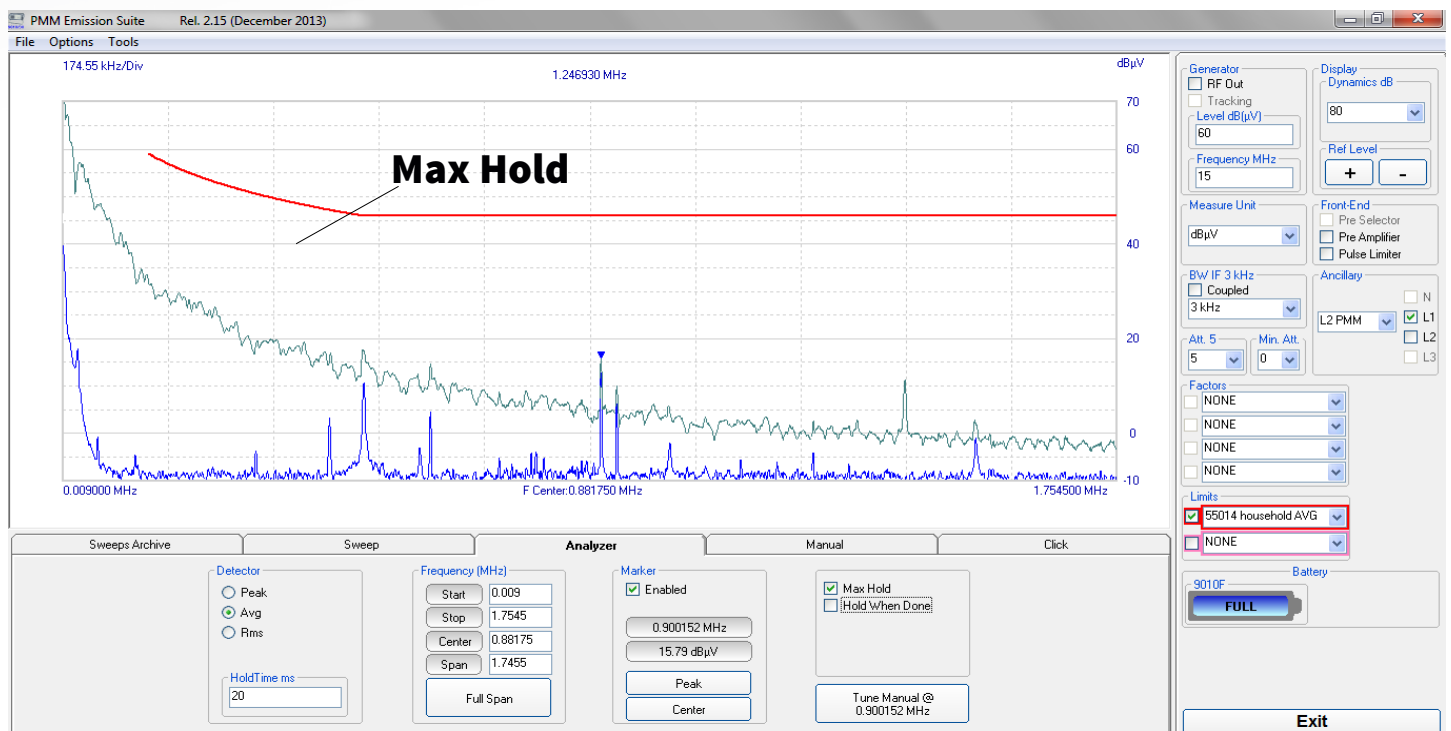

PES: PMM Emission Suite PC Software

The PMM Emission Suite comes with 9010F EMI receiver to expand its applications:

- Full control of all auto and manual Receiver functions
- Real-time display on PC
- One-click operating mode change : Scan/Sweep, Analyzer, Manual
- Import and creation of Limits
- Import and creation of Correction Factors Tables for ancillary equipment (antennas, cables etc.)
- Retrieve, save, recall and compare measurements
- Simultaneous Marker on all Detectors and Zoom
- "n" Highest Peaks Finder and Scan Table generation
- Measured LISN lines scrolling by mouse wheel
- Functions specific to Lighting Equipment (IEC/ EN55015, IEC62493)
- 2D - 3D Waterfall and time analysis (option)
- GTEM correlation to OATS (for radiated measurements)
- Warning messages for incorrect settings
- Report generation
- Import-export of complete measurements
- *Antenna mast - turntable control (option)*

Sweep/Scan Mode

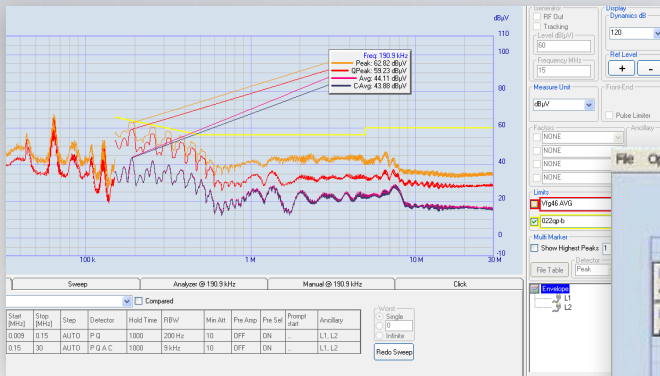

Spectrum Analyzer Mode



Manual Mode

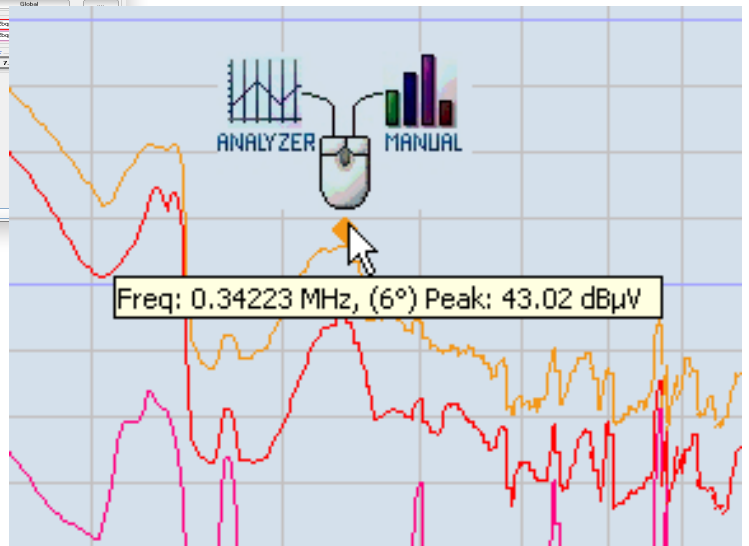
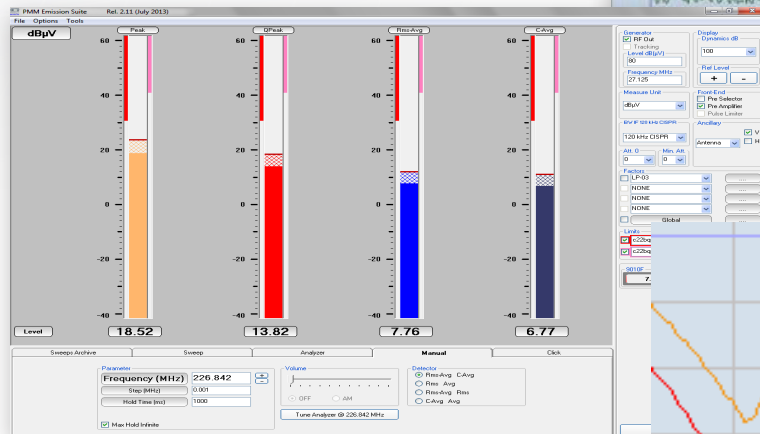

**Just One
Click To Move
Across Functions**



Examples Of Basic Functions

Services Compared

	Start [MHz]	Stop [MHz]	Step	Detector	Hold Time	RBW	Min Att	Pre Amp	Pre Sel	Prompt start	Ancillary
1	76	108	AUTO	P A	50	120 kHz	0	OFF	ON	VHF	...
2	174	241	AUTO	P A	50	1 MHz	0	OFF	ON	DAB	...
3	1452	1492	AUTO	P A	50	1 MHz	0	OFF	ON	DAB-L	...
4	2320	2345	AUTO	P A	5	1 MHz	0	OFF	ON	SDARS	...
5	47	88	AUTO	P A	50	1 MHz	0	OFF	ON	TVI	...

Powerful, clear scan table

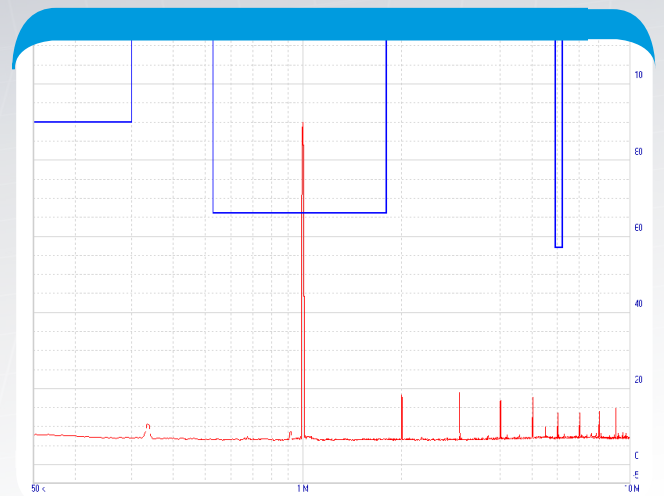
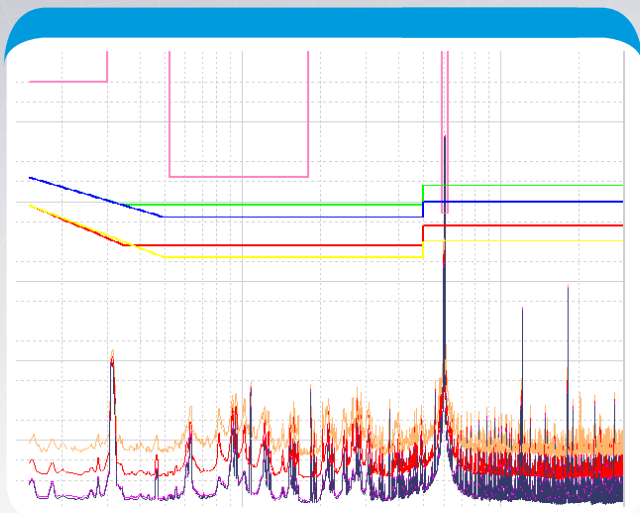

Displaying of up to 5 arbitrary limits

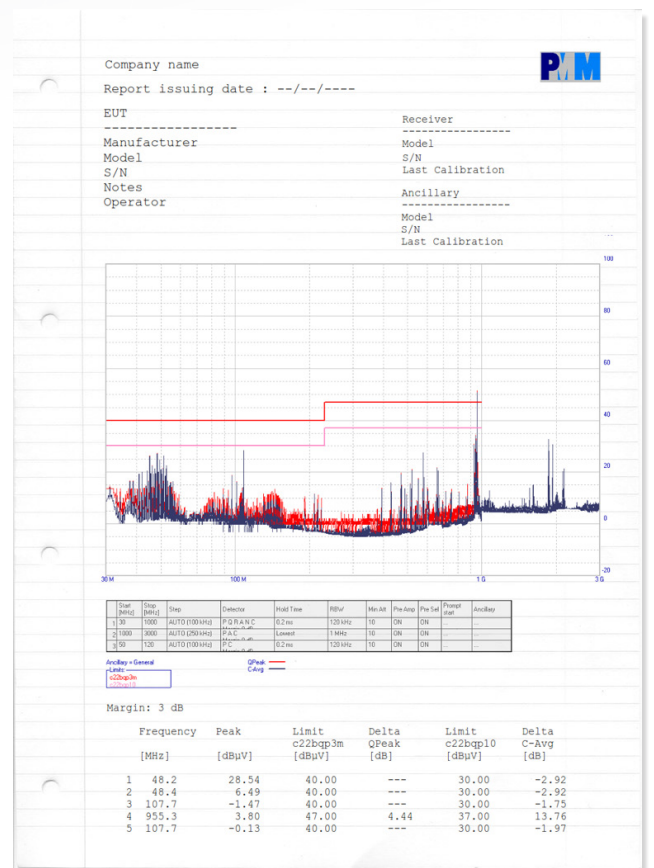
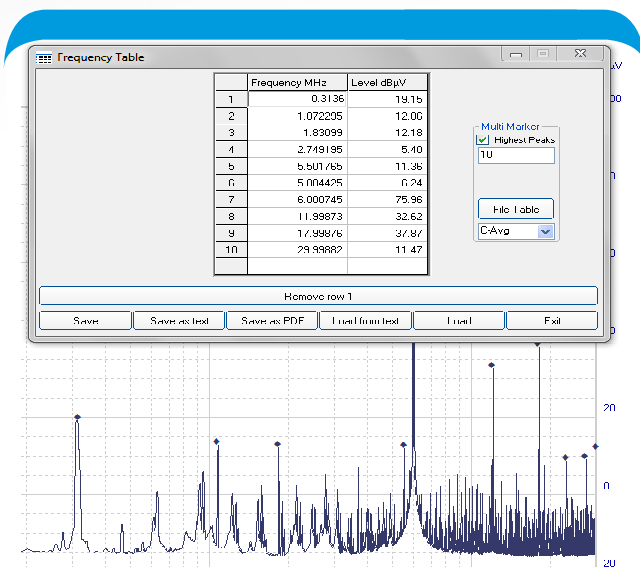

Examples Of Dedicated Functions

	Start [MHz]	Stop [MHz]	Step	Detector	Hold Time	RBW	Min Att	Pre Amp	P
1	0.02	0.15	AUTO	P	100	200 Hz	0	OFF	0
2	0.15	10	AUTO	P	20	9 kHz	0	OFF	0

IEC 62493 requires the exposure of humans to the EMF generated by lighting devices to be assessed by measuring the RF field with a special sensor - the Van der Hoofden Test Head - and by calculating then an adimensional quantity to compare with a reference limit. The whole process is performed by the PMM Emission Suite automatically and safely: just recall the preset frequency table, make the measurement in few seconds thanks to the ultra-fast 9010F and get the result just by one click!

IEC 62493 Annex E

$$F = \sum_{f=20kHz}^{10MHz} \frac{J_{Cap}(f_n)}{J_{Lim}(f_n)} = 0,123$$

F <= 0.85

Pass

OK

9030 GTEM correlation Rel. 1.05 (01 / 2013) Setup Release: 2.00

Sweeps

X: 7010 prova RG_0

Y: 7010 prova RG_0

Z: 7010 prova RG_0

DUT: correlated

Antenna Height

1 - 4 m.

2 - 6 m.

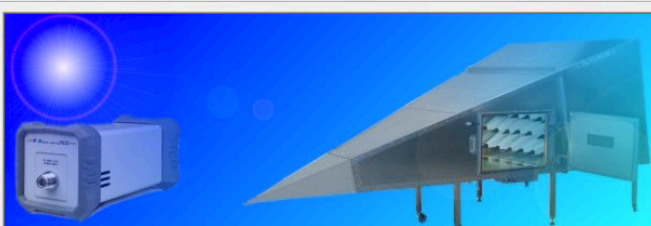

Correlated Distance

3 m.

10 m.

30 m.

Distances

EUT Height: .8 m

Septum Height: 1 m

PMM

Start Exit

Make The Measurement In Few Seconds



G-TEM correlation

According to the EMC Standard EN 61000-4-20, measurements obtained from TEM / G-TEM cells by an EUT rotated along its x-y-z axis can be correlated to those obtained in an OATS (Open Area Test Site) by specific algorithms. The G-TEM correlation function, a standard feature of the PMM Emi Suite, correlates in few clicks the x-y-z measurements into a final measurement spectrum that can be compared with the limits.

Thanks to its speed, the 9010F greatly reduces the time for scanning the x-y-z axis in the requested frequency bands.

Table - Mast

Device: Model NATURO MCU GPIB Address: 0

Table: Min 0 Max 999

Mast: Min 0 Max 999

Polarization: Horizontal Vertical

PreScan [1st Step]: Table [Deg] 0 Mast [cm] 0

Detector: Peak QPeak RMS Avg Rms-Avg C-Avg Hold Time (ms) 1

Measuring [2nd Step]: Scan: Manual Automatic

Frequencies Table: Highest Peaks: 1 Above Limit: C22xp3m Magn [dB] 6

Table [Automatic]: Max Swing 0 Swing Step 0

Mast [Automatic]: Max Swing 0 Swing Step 0

Save: Unlited Delete

Turntable and antenna mast control (option)

This function provides an intuitive but complete setting of two-step - pre-scan and scan - automatic measurements of radiated emissions by controlling the antenna mast and the turntable via GPIB (external controller required - check for the compatibility).

When debugging the antenna and turntable positioning can be set manually and the receiver operated in Manual and Analyzer modes.

Table - Mast

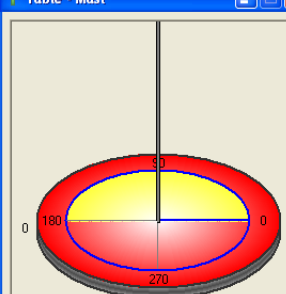

Mast: 0 cm Table: 0 Deg

100 Deg +/-

Simultaneous Time & Frequency Domains Analysis

The extremely fast computing capabilities of 9010F, together with the powerful PMM Emission Suite, allows for collecting subsequent spectra that are displayed in three axis: frequency, amplitude and time, to show at a glance the variations of the spectral components of the disturbance during time.

This allows for faster and better understanding of the disturbance nature by correlating it with the EUT operating cycles, e.g. during its run up - run down phases, and generally may help recognizing intermittent disturbances. The time history of the spectra can be displayed in two ways:

- Waterfall diagram, particularly useful when the spectral contents are relatively limited, e.g. in presence of narrowband disturbances
- Spectrogram diagram showing the peaks amplitude with different colors, more useful for complex, broadband disturbances

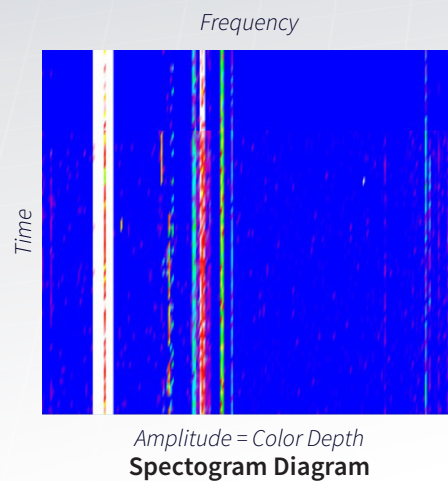
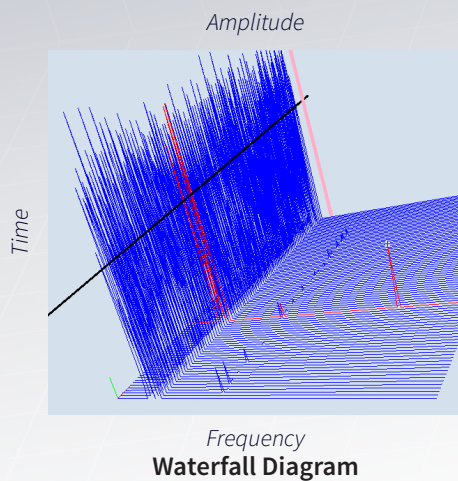

The PMM Emission Suite offers both possibilities on a time history that can last even several hours; a cursor provides all information of each single peak. Display commands include size, scrolling, orientation, dynamic, color management. This function is available on option and can be activated by the user once purchased the activation code.

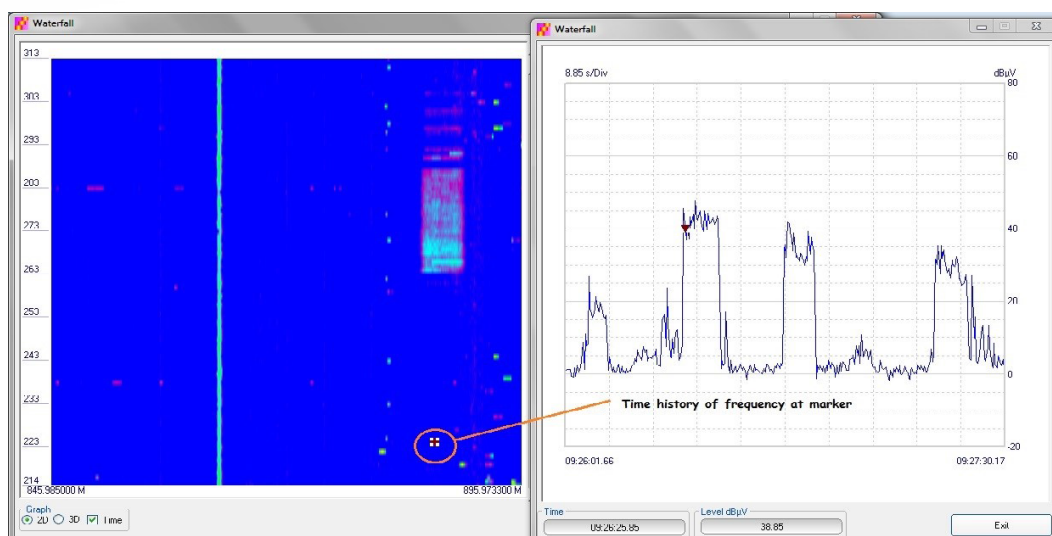

Time history of a single frequency

When a specific frequency is selected by the marker (left) its changes of amplitude during time can be displayed and measured, for an immediate correlation with the EUT operation or cycle that may generate the disturbance.

The 9010F as a Discontinuous Disturbance (Click) Analyzer

In the application of measurement of Discontinuous Conducted Disturbances (Clicks) the 9010F EMI receiver equipped with the Click Option not only guarantees full compliance to the latest CISPR-14-1 requirements: thanks to its fully digital structure it offers superior stability and performance as an Automatic Click Analyzer featuring:

- Wide memory to store each disturbance duration and interval as required by CISPR-14-1
- Automatic worst line search
- Automatic evaluation of Click Rate N
- Automatic use of Exceptions, if applicable
- Automatic Click measurement using Upper Quartile Method
- Exclusive Smart Measure function to speed up tests
- Real time displaying of all events including click details
- Generation of a Report with all mandatory data (and more)

The Click option is activable any time by the user after purchasing the relevant key code.

Smart Measure: how to save test time

Depending on the EUT, the discontinuous disturbances to be assessed as “clicks” may saturate the conventional, analog type Click Analyzers, thus giving false results and needing repeating the test with a great time loss.

The Smart Measure function of the 9010F Click option immediately detects and stores any overloading that may occur during the 1st phase (determination of the Click Rate N) then, on user’s choice, stop and warns the operator or continue the test; the clicks recorder in overloading condition are evidenced in the test report then. If no overloading occurred, the stored values can be used and the 2nd measurement phase can be avoided, reducing the test time to its half.

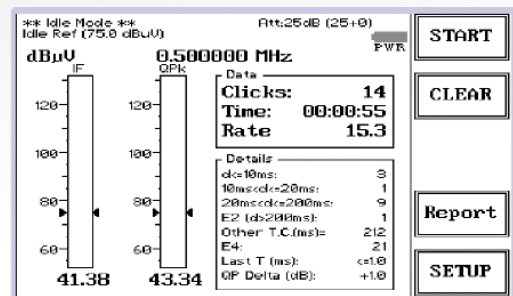
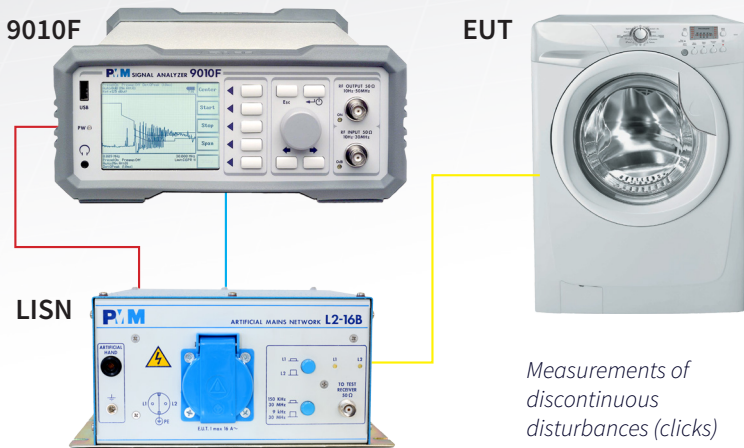

Click Details				
	Duration ms	Interval ms	Delta Level dB	Time s
1	17.5	436.C	...	57.4
2	0.5	> 1000	6.15	98.1
3	13.5	305.C	...	120.7
4	0.5	> 1000	5.32	186.5
5	11.5	> 1000	...	234.7
6	13.5	436.C	...	261.1

Click Meter test report and Click details (PMM Emission Suite)

Lq Calculation										
Frequency MHz	Limit dBµV	<=10ms	<=20ms	<=0.2s	From Exception E4	Other than click ms	Total Clicks	Time min.	N rate	
0.15	66.0	1	0	0	0	0	1	5.0	0.2	Pass E3
0.50	56.0	21	8	1	0	322	31	5.0	6.2	13.7

Final Test Report										
Frequency MHz	Limit Quartile dBµV	<=10ms	<=20ms	<=0.2s	From Exception E4	Other than click ms	Total Clicks	Time min.	Max Click Allowed	Pass Fail
0.50	69.7	4	4	0	0	0	8	5.0	7	FAIL
1.40	69.7	1	0	0	0	0	1	5.0	7	Pass
30.00	73.7	0	0	0	0	0	0	5.0	7	Pass



SPECIFICATIONS 9010F

Frequency range Resolution Frequency accuracy	10 Hz to 30 MHz 0.1 Hz < 1 ppm		
RF input VSWR	Z _{in} 50 Ω, BNC fem. 10 dB RF att. : < 1.2 0 dB RF att. : < 1.6		
Attenuator Preamplifier Gain Pulse limiter	0 dB to 35 dB (5dB steps) 20 dB (after preselector) Built in (selectable)		
Max input level (without equipment damage) Sinewave AC voltage Pulse spectral density	137 dBμV (1 W)* 97 dBμV/MHz		
Preselector	One Low Pass and six Band Pass filters		
IF bandwidth	6 dB bandwidth: 1, 3, 10, 30, 100, 300 kHz (CISPR 16-1-1; 200 Hz, 9 kHz) 6 dB bandwidth: 10, 100 Hz; 1, 10 kHz (MIL-STD option)		
Noise level @ hold time 1s		Quasi-peak (dBμV)	Average (dBμV)
Preselector OFF, Preamplifier OFF	9 kHz to 150 kHz (200 Hz RBW) 0.15 to 30 MHz (9kHz RBW)	< -13 < 5	< -16 < 0
Preselector OFF, Preamplifier ON	9 kHz to 150 kHz (200 Hz RBW) 0.15 to 30 MHz (9kHz RBW)	< -27 < -9	< -30 < -14
Preselector ON, Preamplifier OFF	9 kHz to 150 kHz (200 Hz RBW) 0.15 to 30 MHz (9kHz RBW)	< -7 < 5	< -10 < 0
Preselector ON, Preamplifier ON	9 kHz to 150 kHz (200 Hz RBW) 0.15 to 30 MHz (9kHz RBW)	< -24 < -7	< -27 < -12
Spurious response	Peak, Hold time 100 ms < -7 dBμV, < 3 dBμV, above 150 kHz		
Detectors	Peak, Quasi-Peak, Average, RMS, RMS-Average, C-Average, APD ⁽¹⁾		
Scan time SWEEP MODE FULL CISPR: preselector ON, QP detector	A band (9 - 150 kHz) B band (150 kHz - 30 MHz)	< 5 s < 20 s	Hold time 1 s, 200 Hz RBW Hold time 1 s, 9 kHz RBW
ANALYZER MODE preselector OFF, Peak detector	A band (9 - 150 kHz) B band (150 kHz - 30 MHz)	< 0.5 s 1 s 1 s < 0.1 s	Hold time 2.2 s, 200 Hz RBW Hold time 1 s, 200 Hz RBW Hold time 50 ms, 9, 10 kHz RBW Hold time AUTO, 30 kHz RBW
Level measuring time (Hold time)	CISPR 16-1-1 as default 0.1 ms to 120 s		
Stand alone & measure functions	Marker, marker peak, marker to center, highest peaks, move peak to Analyzer & Manual modes. Store -load: up to 11 traces (sweep mode), two panels, 4 conversion factors. Built-in limits: CISPR 11, 14, 22. Others and custom limits: make and upload by PMM Emission Suite Battery charge and voltage Display style, contrast, backlight CISPR 14 compliant Discontinuous disturbance (Click) measurement (optional)		
Display units Stand Alone With PMM Emission Suite software	dBm, dBμV (80 to 120 dB display dynamic) dBm, dBμV, dBμA, dBpW, dBμV/m, dBμA/m, dBpT (80 to 200 dB display dynamic)		
Measurement accuracy S/N > 20dB	10 Hz to 9 kHz: ± 1.0 dB Typ 9 kHz to 30 MHz: ± 0.8 dB		
RF output Frequency range Level range Level accuracy (10 Hz to 30 MHz)	Tracking (manual mode) & CW generator, Z _{out} 50 Ω, BNC fem. 10 Hz to 50 MHz 60 to 90 dBμV (0.1 dB step) 0.5 dB		
Autocalibration	Internal reference source		
I/O interface	RS-232, High speed Optical (2 channels), USB rear (front for future extension), User port (Drives PMM LISNs and accessories), Bluetooth (optional), IEEE-488 (optional)		
Operating temperature	-5° to 45°C		
Dimensions	235 x 105 x 335 mm		
Weight	4.3 kg		

(* with MIN ATT ≥ 10 dB
(1) soon available

9030 - 9060 - 9180

CISPR 16-1-1 & MIL-STD fully compliant Frequency extensions Modules Specifications

	9030	9060	9180
Frequency range Resolution Frequency accuracy	30 MHz to 3 GHz 100 Hz < 2 ppm	30 MHz to 6 GHz 100 Hz < 2 ppm	6 GHz to 18 GHz 100 Hz < 2 ppm
RF input VSWR 10 dB RF att. 0 dB RF att.	Zin 50 Ω, N fem. < 1.2; <2 over 1 GHz; < 2.0	Zin 50 Ω, N fem < 1.2; <2 over 1 GHz; <2; <3 over 3 GHz	Zin 50 Ω, N fem < 2 < 3
Attenuator	0 dB to 55 dB (5dB steps)	0 dB to 55 dB (5dB steps)	0 dB to 45 dB (5 dB steps)
Preamplifier Gain	10 dB (selectable)	20 dB; 15dB above 1 GHz	20 dB
Max input level (without equipment damage) Sinewave AC voltage Pulse spectral density	137 dBμV (1 W) * 97 dBμV/MHz	137 dBμV (1 W) * 97 dBμV/MHz	137 dBμV (1 W) *
Preselector	Three tracking filters and one bandpass filter 30,0 MHz to 96,6 MHz 96,6 MHz to 311,0 MHz 311,0 MHz to 1,0 GHz	Four tracking filters and two bandpass filters 30,0 MHz to 72,0 MHz 72,0 MHz to 173,0 MHz 173,0 MHz to 416,0 MHz 416,0 MHz to 1 GHz 1 GHz to 3 GHz 3 GHz to 6 GHz	6 GHz to 9 GHz 9 GHz to 12 GHz 12 GHz to 15 GHz 15 GHz to 18 GHz
IF bandwidth 6 dB bandwidth CISPR 16-1-1 bandwidth (6 dB)	3, 10, 30, 100, 300 kHz, 1 MHz (Bimp) 120 kHz 1 MHz (CISPR 16-1-1) B-imp / MIL- STD 6 dB	3, 10, 30, 100, 300 kHz, 1 MHz (Bimp) 120 kHz 1 MHz (CISPR 16-1-1) B-imp / MIL- STD 6 dB	3, 10, 30, 100, 300 kHz 9, 120 kHz – 1 MHz
Noise level (Preamplifier OFF)	30 to 300 MHz (120 kHz BW) <5 dBμV (QP); < 1 dBμV (AV) 300 MHz to 3 GHz (120 kHz BW) < 8 dBμV (QP); < 4 dBμV (AV)	30 to 300 MHz (120 kHz BW) < 10 dBμV (QP); < 7 dBμV (AV) 300 to 3000 MHz (120 kHz BW) < 13 dBμV (QP); < 7 dBμV (AV) 3000 to 6000 MHz (120 kHz BW) < 15 dBμV (QP); < 10 dBμV (AV)	6 to 18 GHz (1 MHz BW) < 28 dBμV (P); < 22 dBμV (AV)
(Preamplifier ON)	30 to 300 MHz (120 kHz BW) < -1 dBμV (QP); < -5 dBμV (AV) 300 MHz to 3 GHz (120 kHz BW) < 2 dBμV (QP); < -2 dBμV (AV)	30 to 300 MHz (10 kHz BW) < - 20 dBμV (AV) 300 to 3000 MHz (10 kHz BW) < - 18 dBμV (AV) 3000 to 6000 MHz (10 kHz BW) < - 12 dBμV (AV)	6 to 18 GHz (10 kHz BW) < -12 dBμV (P); < -17 dBμV (AV)
Spurious response	< 10 dBμV, < 15 dBμV above 1 GHz	< 10 dBμV, < 15 dBμV above 2 GHz	< 20 dBμV
Measurement accuracy S/N > 20 dB	± 1,0 dB	30 to 1000 MHz ± 1.0 dB 1 to 3 GHz ± 1.5 dB 3 to 6 GHz ± 2.0 dB	6 to 18 GHz ± 2.0 dB
I/O Interface	High Speed Optical Link; RS232 (service only)	High Speed Optical Link; RS232 (service only)	High Speed Optical Link; RS232 (service only)
Operating temperature	0° to 40°C	0° to 40°C	-5° to 45°C
Power Supply	10 - 15 Volt DC, 2,5A; Li-Ion interchangeable battery (4 h operations, average); AC universal adapter/charger	10 - 15 Volt DC, 2,5A; Li-Ion interchangeable battery (4 h operations, average); AC universal adapter/charger	10 - 15 Volt DC, 2,5A; Li-Ion interchangeable battery (4 h operations, average); AC universal adapter/charger
Dimensions	235 x 105 x 105 mm	235 x 105 x 335 mm	235 x 105 x 335 mm
Weight	2 kg	2.2 kg	2.2 kg

(*) with MIN ATT ≥ 10 dB

Other EMC Valuable Solutions By Pmm

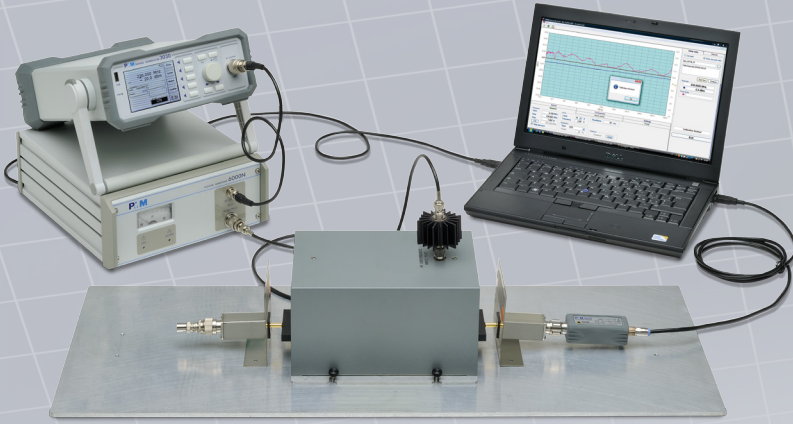

Conducted RF Immunity System

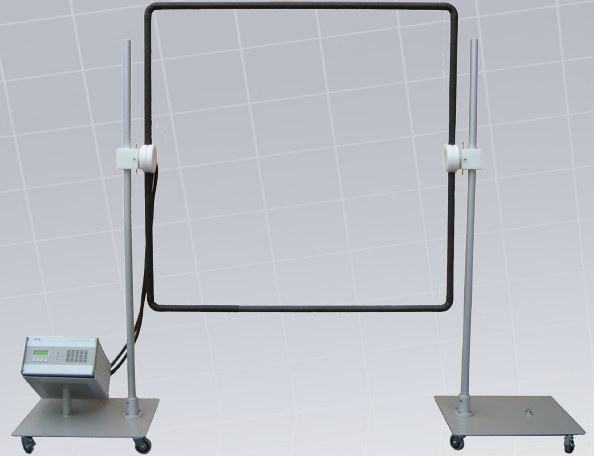

Magnetic Immunity Test System for IEC/EN61000-4-8

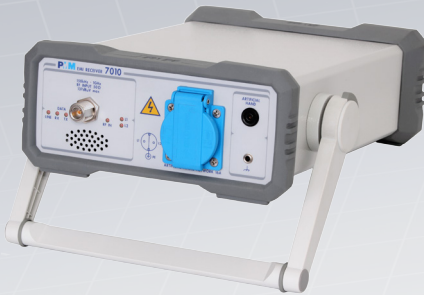

Pre-compliance EMI receivers

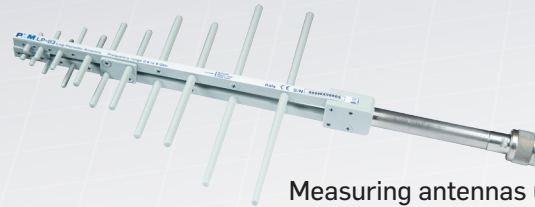

Measuring antennas up to 18 GHz

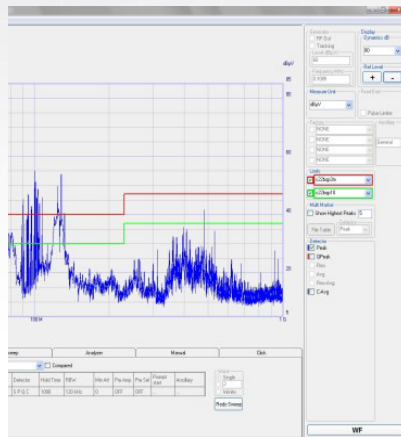
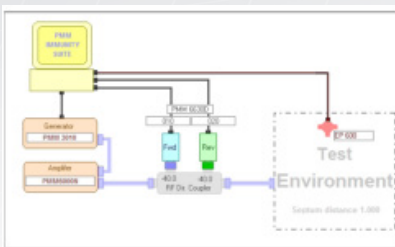

Radiated Immunity System



Isotropic RF Field Probes up to 40 GHz. Accredited calibration

	Optional	Rad-01-00-000 Radiated Immunity up to 140V/m	Rad-01-00-010 Radiated Immunity up to 500V/m	Rad-01-00-020 Radiated Immunity up to 1000V/m
RF Generator	0101	✓	✓	✓
RF Power Meter	0102	✓	optional	optional
Electro Field Probe	EP-0101 EP-0102	✓	✓	✓
RF Amplifier	0103	✓	✓	✓
Antenna	custom	alternative to STEM	alternative to STEM	alternative to STEM
Directional Coupler	custom	optional	optional	optional

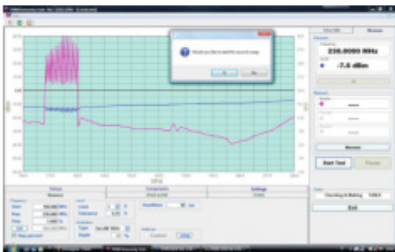

LISN

Services for your PMM EMI Receiver

- Free updating of PC Software and instrument Firmware from our web page.
- Failsafe, User-upgradeable Firmware whenever required by future standards, measuring features and test solutions. An exclusive "parking memory" makes upgrading the PMM Receivers Firmware totally failsafe.
- The fastest and most convenient recalibration and service ever seen before thanks to the modular construction and pre-calibrated subassemblies; provided by our Qualified Sales Partners worldwide network.

Other Services

- Calibration of antennas in OATS in the 20 MHz - 18 GHz frequency range.
- Accredited calibrations for RF power, Frequency, Electric and Magnetic fields strength.

Ordering Information

9010F	9010F FFT Time-domain EMI receiver 10 Hz - 30 MHz, full compliance to CISPR 16-1-1 and MIL-STD 461 (requires option 9010/MIL) Including: - internal tracking generator - battery pack, AC adapter/charger - PC software PMM Emission Suite - Control cables (USB, RS-232), BNC-BNC cable
-------	---

Optional Accessories and Functions

9010/MIL(*)	MIL-STD-461F RBW Filters
9010/RAV(*)	CISPR RMS-AVG detector
9010/CLICK(*)	1-channel Click Analyzer function, CISPR 14-1: 2005 full-compliance, including: - Switching Operation Box, control cables, 2x20 dB attenuator NOTE: field-installable function (advice 9010 S/N for upgrading confirmation)
9010/CLICK4E	External box to connect to a receiver 9010 equipped with 9010/click option. Allows four-channel simultaneous click measurements according to CISPR-14-1-1. AC power only.
9010/BTA(*)	RS-232 to BlueTooth adapter for 9010
9010/GPIB-232CV-A	RS-232 to GPIB (IEEE-488) external adapter for 9010
BP01(*)	Spare Li-Ion Battery Pack for 9010, 9030, 9060 or 9180
9010/AC	AC adapter/charger for BP01, 9010, 9030, 9060 or 9180
9010/FO-xx	20, 50 or 100 m fiber optic cable for 9030, 9060 or 9180
9010/CC	Rigid carrying case for 9010
9010/RMA(*)	19" Rack mount adapter for 9010 Series and 3010, 3030
PES/WF(*)	Waterfall and Spectrogram function of PES-PMM Emission Suite
PES/TM(*)	Table and Mast control function of PES-PMM Emission Suite (Check controller availability)
9010/UKAS	CISPR-16-1-1 accredited calibration certificate for 9010F
9030/UKAS	CISPR-16-1-1 accredited calibration certificate for 9010 & 9030
9060/UKAS	CISPR-16-1-1 accredited calibration certificate for 9010 & 9060
9180/UKAS	CISPR-16-1-1 accredited calibration certificate for 9010 & 9180
9060-9080/UKAS	CISPR-16-1-1 accredited calibration certificate for 9010 & 9060 + 9180
9010/UKAS-Click	UKAS accredited calibration certificate for 9010 + 9010/Click according to CISPR-16-1-1 & CISPR-14-1

Frequency upgrades

9030	Extension unit 30 MHz - 3 GHz, full compliant to CISPR 16-1-1 (UKAS accredited calibration on option)
9060	Extension unit 30 MHz - 6 GHz, full compliant to CISPR 16-1-1 (UKAS accredited calibration on option)
9180	Extension unit 6 - 18 GHz, full compliant to CISPR 16-1-1 (UKAS accredited calibration on option)
	Including: - 20 m fiber optic cable - battery pack with charger - N-male-N-male; adapters - SPA-01, plug-in AC supply adapter (replaces battery) for continuous operation

Ancillary equipments

LISN controlled by the 9010F receiver to automatically select the lines to measure	<ul style="list-style-type: none"> • L1-150M: single-path, 50 Ohm AMN, 150 A • L1-150M1: single-path, 50 Ohm AMN, 150 A • L1-500: single phase AMN, 500 A • L2-16B: 2 lines, 1-phase AMN, 16 A • L3-32: 4 lines, 3-phase AMN, 32 A • L2-16B-CSA: Two Line Single Phase LISN, 16A, 50 Ohm // (5 Ohm+50 mH), 9 kHz - 30 MHz, CSA-listed connectors (Canada) • L3-64: 4 lines, 3-phase AMN, 63 A • L3-64/690V: 4 lines, 3-phase AMN, 63 A • L3-100: 4 lines, 3-phase AMN, 100 A • L3-500: 4 lines, 3-phase AMN, 500 A • L2-D: Delta LISN for telecom, 2 A, 150 Ω
CISPR 16-1-2	<ul style="list-style-type: none"> • SHC-1/1000: Voltage probe, 1000 Vac, 35 dB • SHC-2/1000: Voltage probe, 1000 Vac, 30 dB
Antennas	<ul style="list-style-type: none"> • RA-01: Rod Antenna 9 kHz to 30 MHz • RA01-HV: Rod Antenna 150 kHz to 30 MHz • RA01-MIL: Rod Antenna 9 kHz to 30 MHz • BC-01: Biconical Antenna 30 to 200 MHz • DR-01: Double-ridged Antenna 6 to 18 GHz • LP-02: Log Periodic Antenna 200 MHz to 3 GHz • LP-03: Log Periodic Antenna 800 MHz to 6 GHz • VDH-01: Van der Hoofden test-head 20 kHz to 10 MHz
EN55015 (CISPR 15) components	<ul style="list-style-type: none"> • F-330M-16: CDN 150 kHz to 30 MHz; 250VAC - 16A; 50/60 Hz for power circuitry testing with phase, neutral and PE • RF-300: 3-axis Loop Antenna System For CISPR 15 EN55015 • TRF-1: Balance/unbalance transformer • SBRF4: X-Y-Z Switching Box for automatic operation of RF-300 • VDH-01: Van der Hoofden test-head 20 kHz to 10 MHz • RF-300C: Calibration kit for RF-300 • DL-xx: Dummy lamps according to the standard

The 9010F can also be used with other accessories available on market: LISN, any type; Antennas and Loops; Near Field Probes; TEM/GTEM Cells

(*) User-installable function/accessory

Seles office:

Via Leonardo da Vinci, 21/23
20090 Segrate (Milano) - ITALY
Phone: +39 02 2699871
Fax: +39 02 26998700



A BRAND OF



an iB Communications Company

E-Mail: nardait.support@L-3com.com
Internet: www.narda-sts.it

Headquarter:

Via Benessea, 29/B
17035 Cisano sul Neva (SV) - ITALY
Phone: +39 0182 58641
Fax: +39 0182 586400