

**6500 Series**

# **Loop Antennas**

**User Manual**



 **ETS-LINDGREN**<sup>™</sup>  
An ESCO Technologies Company

ETS-Lindgren Inc. reserves the right to make changes to any product described herein in order to improve function, design, or for any other reason. Nothing contained herein shall constitute ETS-Lindgren Inc. assuming any liability whatsoever arising out of the application or use of any product or circuit described herein. ETS-Lindgren Inc. does not convey any license under its patent rights or the rights of others.

**© Copyright 2013 by ETS-Lindgren Inc. All Rights Reserved. No part of this document may be copied by any means without written permission from ETS-Lindgren Inc.**

Trademarks used in this document: The *ETS-Lindgren* logo is a trademark of ETS-Lindgren Inc.

**Revision Record**  
**MANUAL, 6500 SERIES LOOP ANTENNAS | Part #399293, Rev. A**

Revision	Description	Date
A	Initial Release	November, 2013

# Table of Contents

<b>Notes, Cautions, and Warnings</b> .....	<b>v</b>
<b>1.0 Introduction</b> .....	<b>7</b>
Model 6502.....	8
Model 6507.....	8
Model 6509.....	9
Models 6511 and 6512 .....	9
Standard Configuration.....	10
Optional Items .....	10
Carrying Cases .....	10
Tripod Options .....	10
ETS-Lindgren Product Information Bulletin .....	11
<b>2.0 Maintenance</b> .....	<b>13</b>
Annual Calibration .....	13
Replacement and Optional Parts .....	14
Service Procedures .....	14
<b>3.0 Specifications</b> .....	<b>15</b>
Electrical Specifications .....	15
Model 6502.....	15
Model 6507.....	15
Model 6509.....	16
Models 6511 and 6512.....	16
Battery Charger Specifications: Models 6502 and 6507 .....	17
Physical Specifications: All Models .....	17
<b>4.0 Mounting Instructions</b> .....	<b>19</b>
Additional Mounting Options .....	19
4-TR Mounting Options.....	19
7-TR and Mast Mounting Options.....	20
2x2 Boom Mounting Options.....	21
<b>5.0 Operation</b> .....	<b>23</b>
Front Panel Indicator Lights: Models 6502 and 6507.....	23
Battery Charger: Models 6502 and 6507.....	24

Features and Components.....	24
Fast Charge and Trickle Charge Modes.....	25
<b>6.0 Typical Data .....</b>	<b>27</b>
Model 6502.....	27
Model 6507.....	28
Model 6509.....	29
Model 6511.....	30
Model 6512.....	31
<b>7.0 Radiation Pattern .....</b>	<b>33</b>
Typical Radiated Pattern for an Electrically Small Loop .....	34
<b>Appendix A: Warranty .....</b>	<b>35</b>
<b>Appendix B: 6505 Shielding Effectiveness Test Kit.....</b>	<b>37</b>
Measuring Magnetic Shielding Effectiveness .....	37
Shielding Effectiveness Measurements for Magnetic Field.....	40
<b>Appendix C: EC Declaration of Conformity .....</b>	<b>43</b>
Model 6502.....	43
Model 6507.....	44

## Notes, Cautions, and Warnings

---

	<p><b>Note:</b> Denotes helpful information intended to provide tips for better use of the product.</p>
<p><b>CAUTION</b></p>	<p><b>Caution:</b> Denotes a hazard. Failure to follow instructions could result in minor personal injury and/or property damage. Included text gives proper procedures.</p>
<p><b>WARNING</b></p>	<p><b>Warning:</b> Denotes a hazard. Failure to follow instructions could result in SEVERE personal injury and/or property damage. Included text gives proper procedures.</p>



See the ETS-Lindgren *Product Information Bulletin* for safety, regulatory, and other product marking information.

This page intentionally left blank.

## 1.0 Introduction

---

The **ETS-Lindgren 6500 Series Loop Antennas** include both active and passive antennas. Loop antennas provide a wide range of magnetic field testing. Some models include active electronics for amplification and impedance matching, consistent linear antenna factors, and signal attenuation. Most include a balanced Faraday shield to reduce response to E-fields for pure magnetic field measurements. Whether used individually or as a set, the loop antennas provide an efficient and economical solution to magnetic field measurement.



For information on Model 6505 Shielding Effectiveness Test Kit, see page 37.

Each antenna is individually calibrated in accordance with the IEEE Std 291, using National Institute of Standards and Technology (NIST) traceable equipment. By knowing the actual antenna factors and performance characteristics instead of typical data, you can more accurately measure field strength in your tests. Each antenna includes actual individual calibration factors and signed *Certificate of Calibration Conformance*.

All loop antennas are constructed of lightweight aluminum, which provides durability and reliability for years of trouble-free indoor and outdoor services. The base of each loop antenna provides a standard 1/4–20 threaded connector for mounting to an ETS-Lindgren tripod or other tripod. For the variety of mounting options available, see *Mounting Instructions* on page 19.

## Model 6502

---

The Model 6502 Loop Antenna is an active receiving loop antenna designed to perform commercial emissions standards testing, and can be used for any magnetic testing. The Model 6502 has a frequency range of 9 kHz to 30 MHz.

A radio frequency preamplifier is built into the base of the antenna and provides a 50  $\Omega$  output which is used by a receiver. The preamplifier helps produce good sensitivity and almost constant antenna factors.



Power for the preamplifier is supplied by rechargeable, sealed lead-acid batteries; a battery charger is included. The charger is switch selectable for 115 VAC/230 VAC, and operates at 50 Hz/60 Hz. For more information on the battery charger, see page 17.

## Model 6507

---

The Model 6507 Loop Antenna is an active receiving loop antenna designed to perform shielding effectiveness measurements per MIL-STD 285 and NSA-65-6 specifications. The Model 6507 has a frequency range of 1 kHz to 30 MHz.

A radio frequency preamplifier is built into the base of the antenna designed for use with most 50  $\Omega$  receivers.



Power for the preamplifier is supplied by rechargeable, sealed lead-acid batteries; a battery charger is included. The charger is switch selectable for 115 VAC/230 VAC, and operates at 50 Hz/60 Hz. For more information on the battery charger, see page 17.



## Model 6509

---



When using the Model 6509 as a transmitting device, reduce amplifier power to zero Watts before band switching.

The Model 6509 Passive Loop Antenna is designed for shielding effectiveness and immunity testing. The Model 6509 operates in the frequency range of 1 kHz to 30 MHz. The base contains a Type N female connector and a selectable four-band RF transformer. The RF transformer gives the Model 6509 greater efficiency, which results in a better conversion of input power to field strength.



## Models 6511 and 6512

---

The Model 6511 and Model 6512 are passive loop antennas; the Model 6511 is designed for low frequencies and covers the 20 Hz to 5 MHz range, and the Model 6512 covers the 9 kHz to 30 MHz range.



## Standard Configuration

---

- Antenna/coil assembly
- Mounting base that accepts an ETS-Lindgren tripod or other tripod mount with standard 1/4–20 threaded hardware
- Battery charger (included only with Model 6502 and Model 6507)

## Optional Items

---

### CARRYING CASES

A custom carrying case is available for some of the loop antenna models. For more information, contact ETS-Lindgren.

### TRIPOD OPTIONS

ETS-Lindgren offers the following non-metallic, non-reflective tripods for use at both indoor and outdoor EMC test sites.

- **4-TR Tripod**—Constructed of linen phenolic and delrin, designed with an adjustable center post for precise height adjustments. Maximum height is 2.0 m (80.0 in), and minimum height is 94 cm (37.0 in). This tripod can support up to an 11.8 kg (26.0 lb) load.



- **7-TR Tripod**—Constructed of PVC and fiberglass components, providing increased stability for physically large antennas. The unique design allows for quick assembly, disassembly, and convenient storage. Allows several different configurations, including options for manual or pneumatic polarization. Quick height adjustment and locking wheels provide ease of use during testing. Maximum height is 2.17 m (85.8 in), with a minimum height of 0.8 m (31.8 in). This tripod can support a 13.5 kg (30 lb) load.



### **ETS-Lindgren Product Information Bulletin**

---

See the ETS-Lindgren *Product Information Bulletin* included with your shipment for the following:

- Warranty information
- Safety, regulatory, and other product marking information
- Steps to receive your shipment
- Steps to return a component for service
- ETS-Lindgren calibration service
- ETS-Lindgren contact information

This page intentionally left blank.

## 2.0 Maintenance

---

### CAUTION

Before performing any maintenance, follow the safety information in the ETS-Lindgren *Product Information Bulletin* included with your shipment.



Maintenance of the 6500 Loop Antennas is limited to external components such as cables or connectors.

Warranty may be void if the housing is opened.

If you have any questions concerning maintenance, contact ETS-Lindgren Customer Service.

### Annual Calibration

---

See the *Product Information Bulletin* included with your shipment for information on ETS-Lindgren calibration services.

## Replacement and Optional Parts

---



ETS-Lindgren may substitute a similar part or new part number with the same functionality for another part/part number. Contact ETS-Lindgren for questions about part numbers and ordering parts.

Following are the part numbers for ordering replacement or optional parts for the Model 6500 Series Loop Antennas.

Part Description	Part Number
4-TR Tripod Positioner	4-TR
7-TR Tripod Positioner	7-TR
Battery Charger for Model 6502 and Model 6507	102615
Carrying Case with Foam, Model 6502	6502CASE W/FOAM

## Service Procedures

---

For the steps to return a system or system component to ETS-Lindgren for service, see the *Product Information Bulletin* included with your shipment.

### 3.0 Specifications

---

#### Electrical Specifications

---

##### MODEL 6502

<b>Frequency Range:</b>	9 kHz—30 MHz
<b>Dynamic Range:</b>	85 dB at 10 kHz 125 dB at 1 MHz
<b>Sensitivity (Typical):</b>	-1 dB (uA/m) at 10 kHz -42 dB (uA/m) at 1 MHz
<b>1 dB Compression Point:</b>	5 V/m
<b>Power Required:</b>	Battery-operated
<b>Impedance (Nominal):</b>	50 Ω
<b>Connector:</b>	BNC female

##### MODEL 6507

<b>Frequency Range:</b>	1 kHz—30 MHz
<b>Dynamic Range:</b>	76 dB at 10 kHz 116 dB at 1 MHz
<b>Sensitivity (Typical):</b>	11 dB (mA/m) at 10 kHz -29 dB (mA/m) at 1 MHz
<b>1 dB Compression Point:</b>	10 V/m
<b>Power Required:</b>	13.8 VDC
<b>Impedance (Nominal):</b>	50 Ω
<b>Connector:</b>	BNC female

### MODEL 6509

<b>Frequency Range:</b>	1 kHz—30 MHz
<b>Band 1:</b>	1 kHz—60 kHz
<b>Band 2:</b>	60 kHz—400 kHz
<b>Band 3:</b>	400 kHz—1 MHz
<b>Band 4:</b>	1 MHz—30 MHz
<b>Maximum Input Power:</b>	1 kW
<b>Impedance (Nominal):</b>	Varies with frequency (calibrated in a 50 $\Omega$ system)
<b>Connector:</b>	Type N female

### MODELS 6511 AND 6512

	<b>Model 6511</b>	<b>Model 6512</b>
<b>Frequency Minimum:</b>	20 Hz	9 kHz
<b>Frequency Maximum:</b>	5 MHz	30 MHz
<b>Turns</b>	8	1
<b>Connectors:</b>	BNC female	
<b>Maximum Input Power:</b>	20 W	
<b>Polarization:</b>	Linear	



### Battery Charger Specifications: Models 6502 and 6507

<b>Input Voltage:</b>	115/230 VAC selectable
<b>Input Frequency:</b>	50/60 Hz
<b>Input Power:</b>	20 VA max
<b>Protection Class:</b>	Class II double insulated
<b>Input Fuse Rating:</b>	200 mA time-delay, Type 5x20 mm
<b>Input Power Connection:</b>	IEC-320 power inlet
<b>Output Voltage:</b>	12 VDC (13.5–15 VDC)
<b>Output Current:</b>	350 mA
<b>Safety Approvals</b>	TUV, CSA

### Physical Specifications: All Models

	<b>6511 / 6512</b>	<b>6502</b>	<b>6507</b>	<b>6509</b>
<b>Diameter:</b>	56 cm (22.05 in)	60 cm (23.62 in)	30.4 cm (11.97 in)	30.4 cm (11.97 in)
<b>Height:</b>	59.8 cm (23.54 in)	67.3 cm (26.50 in)	37.8 cm (14.88 in)	47.8 cm (18.82 in)
<b>Length:</b>	3.8 cm (1.50 in)	12 cm (4.72 in)	12 cm (4.72 in)	7.6 cm (2.99 in)
<b>Width:</b>	12.7 cm (5.0 in)	19 cm (7.48 in)	19 cm (7.48 in)	8 cm (3.15 in)
<b>Weight:</b>	1.6 kg (3.53 lb)	2 kg (4.41 lb)	1.8 kg (3.97 lb)	1.3 kg (2.87 lb)

This page intentionally left blank.

## 4.0 Mounting Instructions

---

**CAUTION**

Each loop antenna is a precision measurement device. Handle your antenna with care.

### Additional Mounting Options

---

#### 4-TR MOUNTING OPTIONS

The 6500 Series Loop Antennas mount directly to an ETS-Lindgren 4-TR Tripod; no additional hardware is required.

## 7-TR AND MAST MOUNTING OPTIONS

Following are options for mounting the 6500 Series Loop Antennas onto an ETS-Lindgren 7-TR Tripod or mast. Contact the ETS-Lindgren Sales Department for information on ordering optional mounting hardware.



*Mast* refers to 2070 Series, 2075, and 2175 Antenna Towers.

*7-TR* refers to these booms:

- *109042 boom*—Straight boom; for general antenna mounting on a 7-TR
- *108983 boom*—Offset boom; for general antenna mounting on a 7-TR with pneumatic or manual polarization; can also be used to mount stinger-type antennas
- *118947 boom*—For stinger-type antennas only
- *108507 boom*—Centerline rotation boom for Model 3106 Series antennas only; when changing polarization, maintains centerline rotation

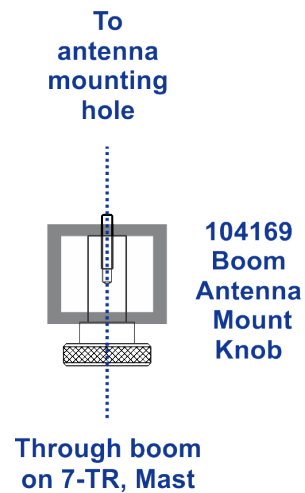

## 2x2 BOOM MOUNTING OPTIONS



*2x2 boom* refers to a typical 2-inch by 2-inch boom.

Following are additional options for mounting the 6500 Series Loop Antennas onto a 2x2 boom. Contact the ETS-Lindgren Sales Department for information on ordering optional mounting hardware.

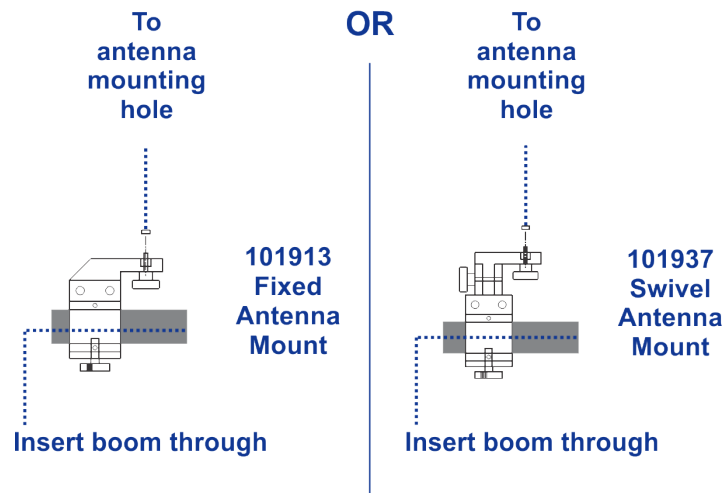

This page intentionally left blank.

## 5.0 Operation

---

### CAUTION

Before connecting any components or placing into operation, follow the safety information in the ETS-Lindgren *Product Information Bulletin* included with your shipment.

### CAUTION

When using the Model 6509 as a transmitting device: Reduce amplifier power to zero watts before band switching, and then select the frequency band by rotating the band switch.



To calculate the field strength:

**Signal Level**  
**+ Cable Loss**  
**+ Antenna Factor**  
**= Relative Field Strength**

Cable loss should be measured periodically for each cable used in testing.

### Front Panel Indicator Lights: Models 6502 and 6507

---

- **Saturation Indicator**—Illuminates when input signal intensity exceeds the 1 dB compression level of 5 volts per meter (Model 6502) to 10 volts per meter (Model 6507), and will remain illuminated for about 1 second.
- **Power Indicator**—Illuminates to show that the loop is on and functional. When the charge on the battery decreases to the point that the antenna calibration is no longer valid, the LED will go dark. However, the antenna will still function and provide reasonable output signals until the batteries are spent.

## Battery Charger: Models 6502 and 6507

---

The Model 6502 and Model 6507 are powered by two 6-VDC, sealed lead-acid batteries. The included battery charger is intended for charging only the sealed lead-acid batteries in ETS-Lindgren products.



The Model 6502 is not designed to operate using the battery charger as a power source.

When the batteries are completely discharged, charging time is approximately eight hours. Batteries should provide power for approximately 16 hours before recharging is required.

### FEATURES AND COMPONENTS

- **Voltage selection switch**—The battery charger is voltage-selectable, providing the necessary charge voltage and current from either a 115 or 230 VAC 50/60 Hz source. The voltage selection switch is located next to the power input receptacle.



Select the proper input voltage before connecting the battery charger to the power mains.

- **Power On**—Illuminates when the charger is plugged into an AC outlet.
- **Battery charging port**—Located on the front of the unit.

### CAUTION

**Always remove main power before opening the battery charger case.**

- **Fuse**—A 200 mA 250 VAC time-delay fuse protects against overcurrent. When replacing the fuse, use a fuse of the same type and rating to maintain safe operations; see the battery charger specifications on page 17 for more information. The fuse is accessible by removing the two Phillips head screws on the bottom of the unit.



- **Power cord**—To maintain safety requirements, use the safety-approved power cord provided. If you use another method to attach the battery charger to the power mains, use only a type HD21 (PVC cord) or type HD22 (rubber cord) with a nominal cross-section of 0.75 mm<sup>2</sup>.

### FAST CHARGE AND TRICKLE CHARGE MODES

The battery charger provides both fast and trickle charge operation. Switching from one charge mode to the other occurs automatically.

- **Fast Charge mode**—The battery charger is in fast charge mode when the **Fast Charge** LED is illuminated. This LED illuminates when the battery is charging, and becomes darker or blinks when the battery is fully charged. When the battery charger completes the fast charge cycle, it will automatically switch to trickle charge mode.
- **Trickle Charge mode**—The battery charger is in trickle charge mode when the **Power On** LED is illuminated and the **Fast Charge** LED is dark.



When not in use, connect the loop antenna to the battery charger in trickle charge mode.

This page intentionally left blank.

## 6.0 Typical Data

### Model 6502

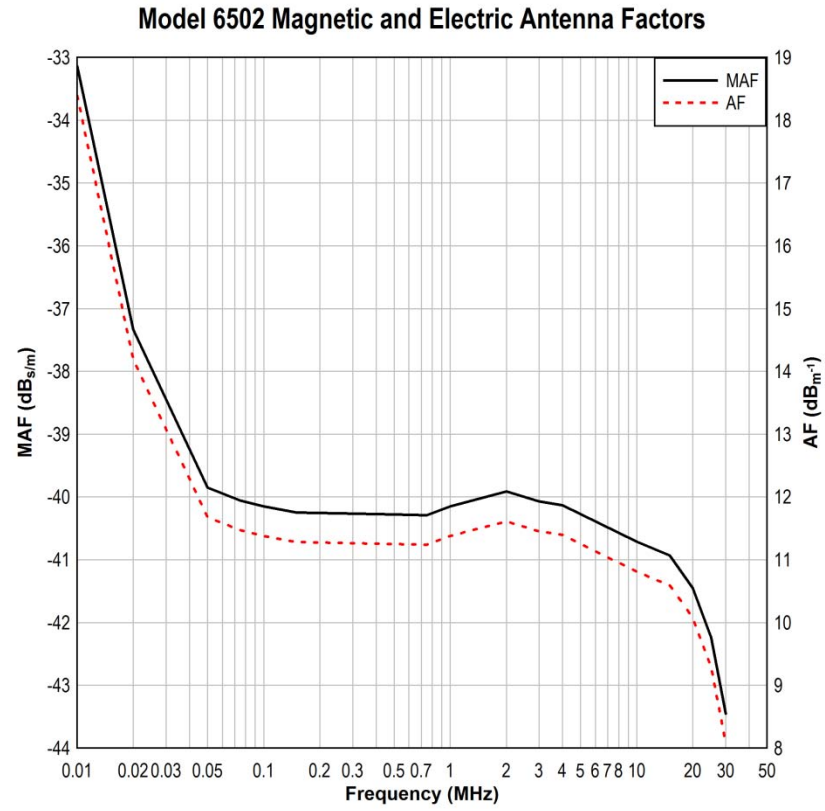

## Model 6507

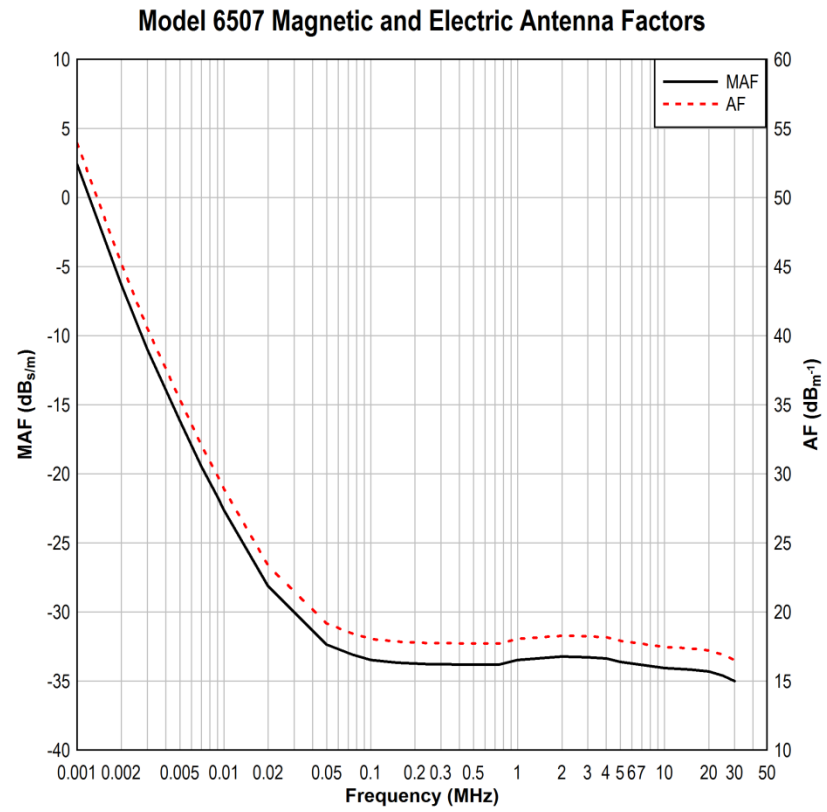

# Model 6509

## Model 6509 Magnetic and Electric Antenna Factors

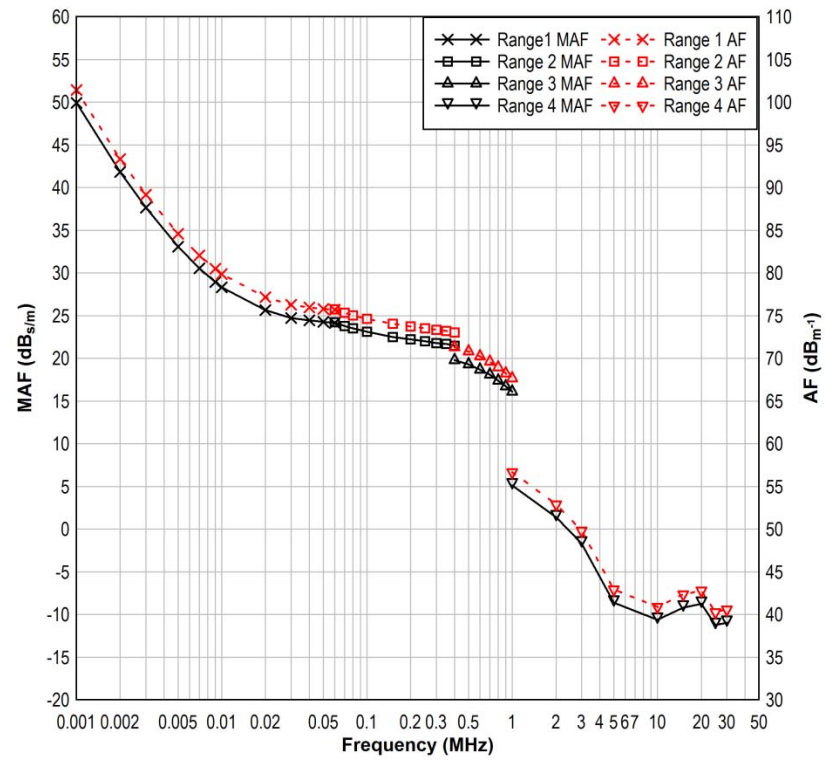

## Model 6511

### Model 6511 Magnetic and Electric Antenna Factors

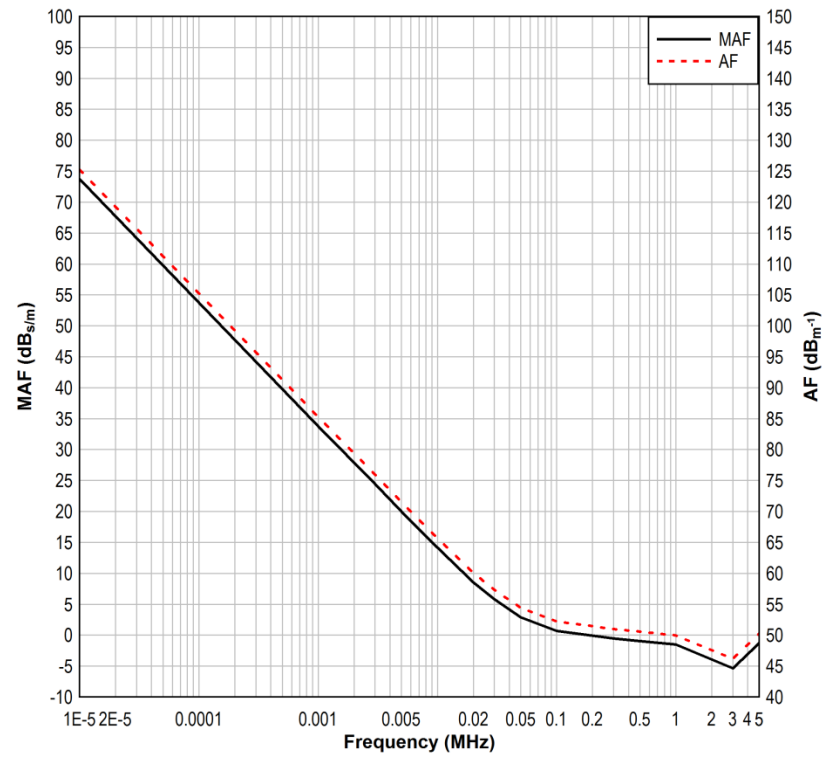

## Model 6512

### Model 6512 Magnetic and Electric Antenna Factors

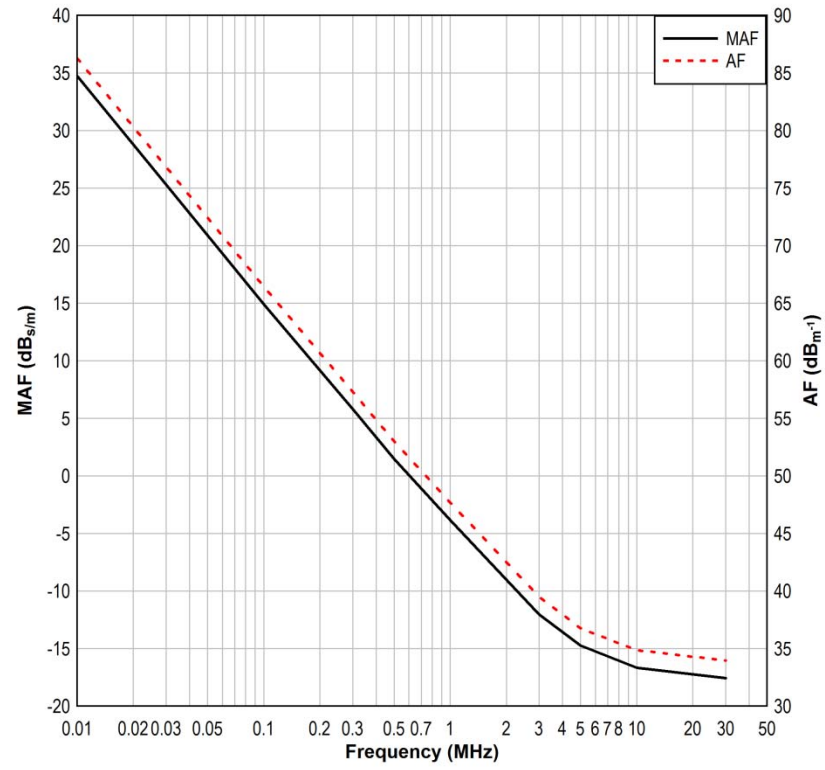

This page intentionally left blank.



## 7.0 Radiation Pattern

---

The 6500 Series Loop Antennas are electrically small loops (size is small in wavelengths), giving them identically-shaped radiation patterns. Each loop operates at a frequency under 30 MHz. At 30 Hz the wavelength is 10 m; the largest loops have a circumference of 1.88 m ( $C=\pi D$ ), which is much smaller than the wavelength.

For electrically small loops it can be assumed that the current on the loop is constant. If we place the loop on the plane  $z=0$  so that the  $z$ -axis is perpendicular to the plane of the loop and following the derivation presented by Balanis in *Antenna Theory: Analysis and Design* (2nd Ed. John Wiley and Sons: New York 1997), it follows that the radiated magnetic fields are given by:

$$H_r = j \frac{ka^2 I_0 \cos\theta}{2r^2} \left[ 1 + \frac{1}{jkr} \right] e^{-jkr}$$
$$H_\theta = - \frac{(ka)^2 I_0 \sin\theta}{4r} \left[ 1 + \frac{1}{jkr} - \frac{1}{(kr)^2} \right] e^{-jkr}$$
$$H_\phi = 0$$

And the radiated electric fields are given by:

$$E_r = E_\theta = 0$$
$$E_\phi = \eta \frac{(ka)^2 I_0 \sin\theta}{4r} \left[ 1 + \frac{1}{jkr} \right] e^{-jkr}$$

## Typical Radiated Pattern for an Electrically Small Loop

The following illustrates the typical radiated pattern for an electrically small loop.

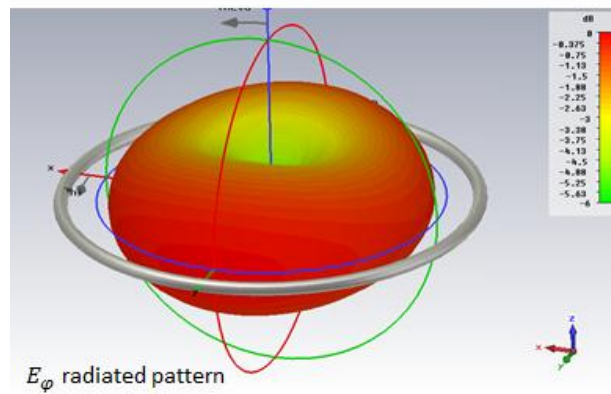
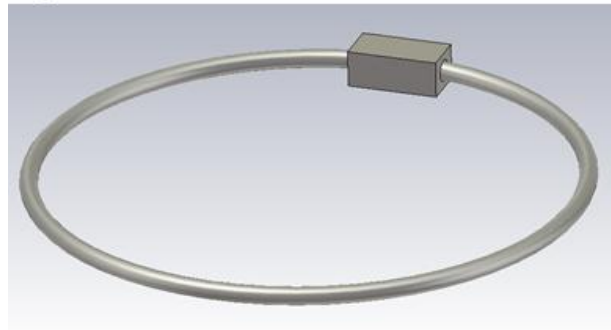
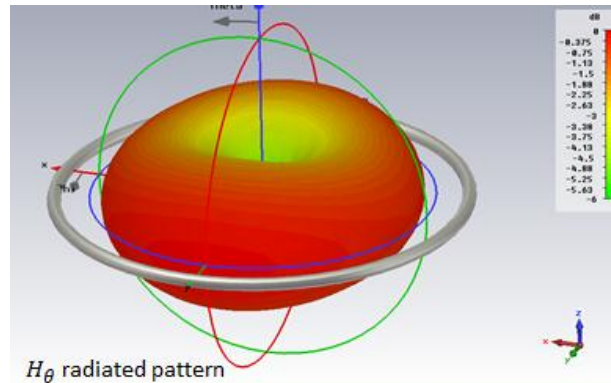

## Appendix A: Warranty

---



See the *Product Information Bulletin* included with your shipment for the complete ETS-Lindgren warranty for your 6500 Series Loop Antenna.

### DURATION OF WARRANTIES FOR 6500 SERIES LOOP ANTENNA

All product warranties, except the warranty of title, and all remedies for warranty failures are limited to two years.

Product Warranted	Duration of Warranty Period
Model 6502 Loop Antenna	2 Years
Model 6507 Loop Antenna	
Model 6509 Passive Loop Antenna	
Model 6511 Shielded Loop Antenna	
Model 6512 Shielded Loop Antenna	

This page intentionally left blank.

## **Appendix B: 6505 Shielding Effectiveness Test Kit**

---

The ETS-Lindgren Model 6505 Loop Shielding Effectiveness Test Kit is a set of loop antennas that includes the following:

- Model 6507 Active Receiving Loop Antenna
- Model 6509 Passive Loop Antenna
- Battery Charger

### **Measuring Magnetic Shielding Effectiveness**

---

1. Set the transmitting and receiving antennas apart at a distance equal to 24 inches plus the thickness of screen room.
2. Set up equipment as shown in the diagram on page 39.
3. Turn generator to on position.
4. Disable RF output of generator.
5. Turn amplifier to on position.
6. Turn receiver to on position.
7. Turn receiver loop power on, and verify light is on.
8. Set desired frequency on generator. Set the same frequency on receiver.
9. Set the attenuator at maximum (100–120 dB) attenuation.
10. Enable RF output of the generator.

11. Adjust signal amplitude on signal generator to maximum allowed by amplifier input. Establish a reference level by decreasing the attenuation level until the signal can be detected by the screen room wall between them. Reduce attenuation further until signal is again seen at the same level as without shielding.

The difference in the two attenuator settings is the shielding effectiveness. If the signal cannot be seen with a zero setting, then the shielding effectiveness is greater than the attenuation range, or the power amplifier does not have enough power.



The shielding effectiveness readings are valid only if the power amplifier is operating in the linear region. This can be verified by reducing (or increasing) attenuation and observing the receiver signal on the analyzer or receiver. If the receiving signal also decreases (or increases) by the same amount, then the amplifier is operating in the linear region.

**Reference:**

- MIL-STD 285
- NSA 65-6

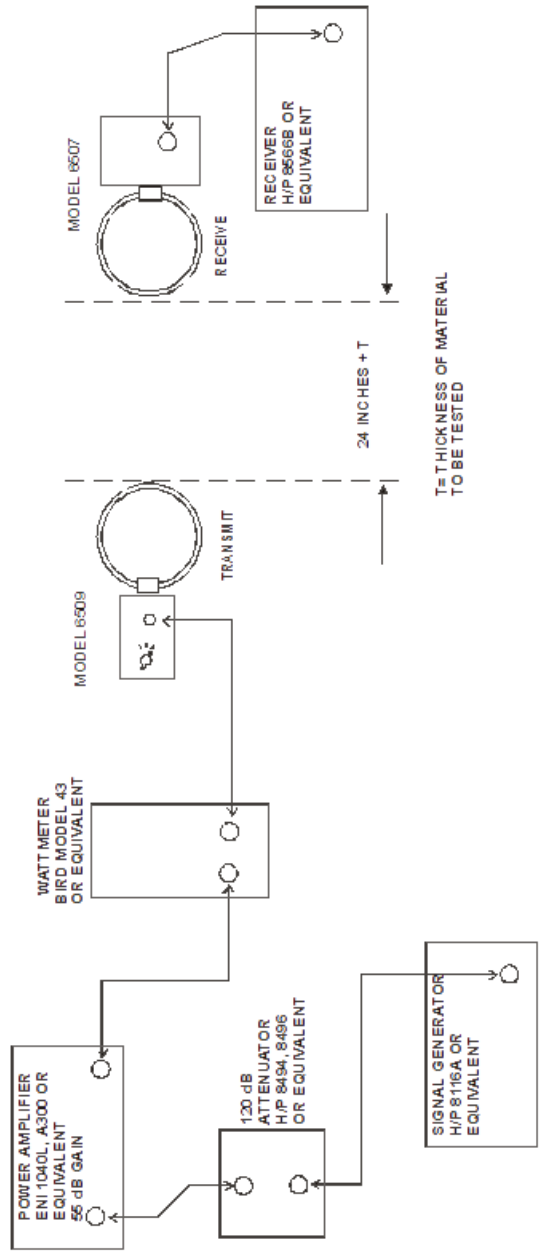

FIGURE 1. SUGGESTED TEST SET-UP FOR  
ELECTRIC SHIELDING EFFECTIVENESS TESTING

## Shielding Effectiveness Measurements for Magnetic Field

Frequency	MSA 65-5 Minimum Attenuation for Magnetic Field	Approximate Wattage Required to meet MSA 65-6 attenuation specifications	Maximum Shielding (Magnetic Field) that can be measured with this setup
<b>Band 1</b>			
1 kHz	20 dB	< 5	50 dB
10	56	< 5	82
20	68	< 5	90
30	74	< 5	95
40	78	< 5	97
50	80	< 5	99
60	84	< 5	100
<b>Band 2</b>			
60	84	< 5	100
70	86	< 5	100
80	88	< 5	100
90	89	5	100
100	90	5	103
200	95	5	105
300	97	20	110
400	98	10	110



Frequency	MSA 65-5 Minimum Attenuation for Magnetic Field	Approximate Wattage Required to meet MSA 65-6 attenuation specifications	Maximum Shielding (Magnetic Field) that can be measured with this setup
<b>Band 3</b>			
400	98	10	110
500	99	15	110
600	99	30	120
700	99	50	120
800	100	40	120
900	100	25	120
1000	100	40	120
<b>Band 4</b>			
1 MHz	100	40	120
2	100	25	120
4	100	20	120
6	100	15	120
8	100	15	120
10	100	15	120
15	100	20	120
20	100	25	120
25	100	25	120
30	100	30	120

This page intentionally left blank.

## Appendix C: EC Declaration of Conformity

---

Model 6502

---

# EUROPEAN COMMUNITY DECLARATION OF CONFORMITY

---

The EC Declaration of Conformity is the method by which EMC Test Systems, L.P. declares that the equipment listed on this document complies with the EMC and Low-voltage Directives.

**Factory:**

EMC Test Systems, L.P.  
P.O. Box 80589  
Austin, Texas USA  
78708-0589

**Issued by:**

EMC Test Systems, L.P.  
P.O. Box 80589  
Austin, Texas USA  
78708-0589

The products manufactured under the EMCO product name and listed below are eligible to bear the EC Mark:

Model 6502 Active Loop Antenna  
Part Number 102615 Battery Charger

**Applicable Requirements:**

<u>Standard</u>	<u>Criteria</u>
EN61010-1	Safety requirements for electrical equipment for measurement, control and laboratory use
EN60742/1989	Isolating transformers and safety isolating transformers
EN55022	Class B
IEC 801-2	Level 2 4/8kV
IEC 801-3	Level 2 3V/m
IEC 801-4	Level 2 .5 I/O, 1kV AC

**Authorized Signatories**

  
Bruce Butler, General Manager

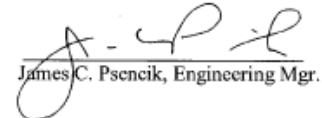
  
James C. Psencik, Engineering Mgr.

  
Charles Garrison, Quality Assurance

**Date of Declaration: December 10, 1996**

The authorizing signature on the EC Declaration of Conformity document authorizes EMC Test Systems, L.P. to affix the CE mark to the indicated product. CE marks placed on these products will be distinct and visible. Other marks or inscriptions liable to be confused with the CE mark will not be affixed to these products. EMC Test Systems, L.P. has ensured that appropriate documentation shall remain available on premises for inspection and validation purposes for a period of no less than 10 years.

## Model 6507

### EUROPEAN COMMUNITY DECLARATION OF CONFORMITY

The EC Declaration of Conformity is the method by which EMC Test Systems, L.P. declares that the equipment listed on this document complies with the Low-voltage and EMC Directives.

**Factory:**

EMC Test Systems, L.P.  
P.O. Box 80589  
Austin, Texas USA  
78708-0589

**Issued by:**

EMC Test Systems, L.P.  
P.O. Box 80589  
Austin, Texas USA  
78708-0589

**The products manufactured under the EMCO product name and listed below are eligible to bear the EC Mark:**

Model 6507 Active Loop Antenna  
Part Number 102615 Battery Charger

**Applicable Requirements:**

Standard	Criteria
EN61010-1	Safety requirements for electrical equipment for measurement, control and laboratory use
EN60742/1989	Isolating transformers and safety isolating transformers
EN55022	Class B
IEC 801-2	Level 2 4/8kV
IEC 801-3	Level 2 3V/m
IEC 801-4	Level 2 .5 I/O, 1kV AC

**Authorized Signatories**

  
Bruce Butler, General Manager

  
Charles Garrison, Quality Assurance

  
James C. Psencik, Engineering Mgr.

**Date of Declaration: December 10, 1996**

The authorizing signature on the EC Declaration of Conformity document authorizes EMC Test Systems, L.P. to affix the CE mark to the indicated product. CE marks placed on these products will be distinct and visible. Other marks or inscriptions liable to be confused with the CE mark will not be affixed to these products. EMC Test Systems, L.P. has ensured that appropriate documentation shall remain available on premises for inspection and validation purposes for a period of no less than 10 years.